

**EVALUATION OF MECHANISMS OF EXHAUST INTRUSION INTO SCHOOL  
BUSES AND FEASIBLE MITIGATION MEASURES**

**FINAL REPORT**

**Prepared for the California Air Resources Board**  
Contract No. 03-343

**Principal Investigator**

Dennis R. Fitz

College of Engineering  
Center for Environmental Research and Technology  
University of California  
Riverside, CA 92521

**Co-Principal Investigator**

Arthur M. Winer, Ph.D.

Environmental Health Sciences Department  
Environmental Science and Engineering Program  
School of Public Health  
University of California  
Los Angeles, CA 90095

**Participating Researchers**

Kathleen Kozawa, Eduardo Behrentz  
Environmental Health Sciences Department  
Environmental Science and Engineering Program  
School of Public Health  
University of California  
Los Angeles, CA 90095

David Pankratz, David Gemmill  
College of Engineering  
Center for Environmental Research and Technology  
University of California  
Riverside, CA 92521

January 11, 2006

## **DISCLAIMER**

The statement and conclusions in the Report are those of the contractor and not necessarily those of the California Air Resources Board. The mention of commercial products, their source, or their use in connection with material reported herein is not to be construed as actual or implied endorsement of such products.

## ACKNOWLEDGEMENTS

We thank Allen Weber at Savanna River National Laboratory, Professor William Hinds at UCLA, and Professor Ring Carde at UCR for the use of their instruments on-board the school buses.

We gratefully acknowledge the staff at Hemet Unified School District for all of their help and the use of their buses.

We wish to acknowledge Kurt Bumiller and David Cocker and UCR students James Bristo, Sally Pederson, Adrian Afan, and Cameron Switzer, for their contributions to this research.

We especially appreciated Cheryl Benson, Lynda Owens-Wolfe, Delvin Lucas, and Walter “Bud” Morris of the UCR Transportation Department and Henry Coleman of the UCLA Transportation Department for their professional driving of the school buses and support of the project team. We also thank Lance Danks at the UCR Transportation Department for helping to arrange drivers and a bus for the study.

We gratefully acknowledge support for this research by the California Air Resources Board. This report was submitted in partial fulfillment of ARB Contract No. 03-343, “Evaluation of Exhaust Intrusion in School Buses and Feasible Mitigation Measures,” by the University of California, Riverside, College of Engineering, Center for Environmental Research and Technology and the University of California, Los Angeles, School of Public Health, Environmental Health Sciences Department, under the sponsorship of the California Air Resources Board. Work was completed as of June 2006.

## TABLE OF CONTENTS

|   |     |
|---|-----|
| <b>DISCLAIMER</b> .....   | i   |
| <b>ACKNOWLEDGEMENTS</b> .....   | ii  |
| <b>TABLE OF CONTENTS</b> .....  | iii |
| <b>LIST OF FIGURES</b> .....  | vi  |
| <b>LIST OF TABLES</b> .....   | ix  |
| <b>LIST OF PHOTOGRAPHS</b> .....  | xi  |
| <b>ABSTRACT</b> .....   | xii |
| <b>1.0 EXECUTIVE SUMMARY</b> .....  | 1   |
| <b>2.0 INTRODUCTION AND BACKGROUND</b> .....                                      | 3   |
| 2.1 Introduction .....  | 3   |
| 2.2 Background .....  | 3   |
| 2.3 Statement of Problem.....   | 4   |
| 2.4 Previous Vehicle Exhaust Intrusion Studies .....                              | 4   |
| 2.4.1 Mechanisms of Exhaust Intrusion Studies .....                               | 5   |
| 2.4.2 Other Related Exhaust Intrusion Studies .....                               | 6   |
| 2.4.2.1 Ventilation Air Flow Patterns Inside Vehicles.....                        | 6   |
| 2.4.2.2 Air Exchange Rate Studies .....   | 7   |
| 2.5 Objectives.....   | 8   |
| 2.5.1 Overall Objectives.....   | 8   |
| 2.5.2 Specific Objectives.....  | 8   |
| 2.5.2.1 Pilot Study .....   | 8   |
| 2.5.2.2 Main Study .....  | 8   |
| <b>3.0 PILOT STUDY FINDINGS AND RECOMMENDATIONS</b> .....                         | 9   |
| 3.1 Introduction .....  | 9   |
| 3.2 Summary of Pilot Study Findings.....  | 9   |
| 3.2.1 Evaluation of Exhaust System Leaks .....                                    | 9   |
| 3.2.2 Evaluation of Leak Points in the Passenger Cabin and Exhaust Intrusion..... | 9   |
| 3.2.3 SF <sub>6</sub> Tracer Gas Release System .....                             | 11  |
| 3.2.4 Evaluation of Leader Vehicle Exhaust Intrusion .....                        | 12  |
| 3.2.5 Evaluation of Proposed Mitigation Strategies.....                           | 12  |
| 3.3 Modifications of Experimental Design for Main Study.....                      | 13  |
| <b>4.0 EXPERIMENTAL METHODS AND STUDY DESIGN</b> .....                            | 14  |
| 4.1 Introduction .....  | 14  |
| 4.1.1 Vehicle Selection.....  | 14  |
| 4.1.2 Fuel Used in the Test Buses .....   | 14  |
| 4.1.3 Characterization and Justification of Selection of Test Routes.....         | 14  |
| 4.1.3.1 Route 1.....  | 15  |
| 4.1.3.2 Route 2.....  | 16  |
| 4.2 Field Sampling Procedures .....   | 16  |
| 4.2.1 Instrument Packaging and Supply.....  | 16  |
| 4.2.2 Instrumentation .....   | 17  |
| 4.2.2.1 SF <sub>6</sub> Measurements .....  | 17  |
| 4.2.2.2 Real-Time Particle Phase PAH Measurements .....                           | 17  |
| 4.2.2.3 Condensation Particle Counts (CPC) .....                                  | 18  |
| 4.2.2.4 Bus Location.....   | 18  |

|   |           |
|---|-----------|
| 4.2.2.5 Engine Operating Parameters .....   | 18        |
| 4.2.2.6 Propene Measurements .....  | 18        |
| 4.2.2.7 Meteorological Measurements .....   | 18        |
| 4.2.2.8 Video Camera .....  | 18        |
| 4.2.2.9 Tracer Release Control .....  | 19        |
| 4.2.3 Data Collection .....   | 19        |
| 4.2.4 Experimental Design .....   | 19        |
| 4.2.4.1 Evaluation of Exhaust Train Leaks .....   | 19        |
| 4.2.4.3 Evaluation of Tailpipe Exhaust Intrusion (Self-Pollution) .....                                 | 21        |
| 4.2.4.3.1 Tracer Gas Release System .....   | 21        |
| 4.2.4.3.2 Self-Pollution Runs .....   | 21        |
| 4.2.4.4 Evaluation of Exhaust Intrusion from a Leader Vehicle .....                                     | 25        |
| 4.3 Baseline Tracer Gas Measurements .....  | 27        |
| 4.4 Data Analysis Methods .....   | 27        |
| <b>5.0 RESULTS AND DISCUSSION .....</b>   | <b>28</b> |
| 5.1 Tracer Gas Release System .....   | 30        |
| 5.1.1 Validation .....  | 30        |
| 5.1.1.1 Pearson’s Correlation Coefficient .....   | 31        |
| 5.1.1.2 Tracer Gas Concentration in Exhaust .....   | 33        |
| 5.2 Bus Cabin Leak Potential .....  | 36        |
| 5.2.1 Evaluation of Overall Bus Cabin Leak Potential .....  | 36        |
| 5.2.1.1 Rapid Evaluation of Overall Cabin Leak Rate .....   | 36        |
| 5.2.2 Quantification .....  | 37        |
| 5.3 Exhaust Leaks .....   | 37        |
| 5.4 Mitigation Measures .....   | 39        |
| 5.4.1 Effect of High Exhaust Position When Driven on the Test Route .....                               | 39        |
| 5.4.1.1 Effect of High Exhaust Position on Self-Pollution When Bus in Motion .....                      | 39        |
| 5.4.1.2 Effect of High Exhaust Position in Leader Bus on Follower Bus .....                             | 44        |
| 5.4.2 Effect of Power Ventilation (Blower) When Bus in Motion .....                                     | 46        |
| 5.4.2.1 Effect of Power Ventilation on Self-Pollution when Bus in Motion, Low Exhaust Location .....    | 46        |
| 5.4.2.2 Effect of Power Ventilation in the Test Bus while Following a Leader Bus with Low Exhaust ..... | 48        |
| 5.4.3 Combination of High Exhaust and Power Ventilation (Blower) When Driven on the Test Route .....    | 49        |
| 5.4.3.1 Effect of Combined High Exhaust and Power Ventilation on Self-Pollution ....                    | 49        |
| 5.4.3.2 Effect of Combined High Exhaust in Leader Bus and Power Ventilation on Follower Bus .....       | 52        |
| 5.6 Stationary Runs .....   | 57        |
| 5.6.1 Self-Pollution during Stationary Runs .....   | 60        |
| 5.7 Comparison to Previous School Bus Study .....   | 69        |
| 5.7.1. Comparison of Tracer Gas Release Systems and Tracer Gas Concentrations in Exhaust .....          | 69        |
| 5.7.2. Comparison of Buses and Routes .....   | 70        |
| 5.7.3 Effects due to Differences in Run Duration .....  | 70        |
| 5.7.4 Summary of Comparisons between Studies .....  | 71        |

|   |    |
|---|----|
| <b>6.0 CONCLUSIONS AND RECOMMENDATIONS</b> .....                        | 73 |
| 6.1 Exhaust Leak Potential and Bus Cabin Leak Potential.....            | 73 |
| 6.2 Tracer Gas Release System.....                                      | 73 |
| 6.3 Mitigation Strategies .....   | 73 |
| 6.3.1 Mobile Runs .....   | 73 |
| 6.3.2 Stationary Runs .....   | 74 |
| 6.4 Comparison to Previous Bus Study .....                              | 74 |
| 6.5 Recommendations .....   | 74 |
| <b>7.0 RECOMMENDATIONS FOR FUTURE RESEARCH</b> .....                    | 75 |
| <b>8.0 REFERENCES</b> .....   | 78 |
| <b>9.0 INVENTIONS REPORTED AND COPYRIGHTED MATERIALS PRODUCED</b> ..... | 81 |
| <b>10.0 GLOSSARY OF TERMS, ABBREVIATIONS, AND SYMBOLS</b> .....         | 82 |

## LIST OF FIGURES

| <b><u>Figure No.</u></b> | <b><u>Title</u></b>   | <b><u>Page</u></b> |
|--------------------------|---|--------------------|
| 3.2.3.1                  | Tracer gas release system used in main study, using two tracer gases. The system was controlled by engine intake flow. ....   | 11                 |
| 4.1.3.1.1                | Map of Route 1 in Riverside, California.....  | 15                 |
| 4.1.3.2.1                | Map of Route 2 in Downtown Riverside, California.....   | 16                 |
| 5.1.1.1.1                | Pearson’s correlation coefficient for each day of mobile testing in the main study .....  | 31                 |
| 5.1.1.1.2                | Scatter plots of exhaust flow versus SF <sub>6</sub> flow rate for 0427/Run 44.....   | 32                 |
| 5.1.1.1.3                | Scatter plots of exhaust flow versus propene flow rate for 0427/Run 44.....   | 32                 |
| 5.1.1.2.1(a,b)           | Time series of one-minute medians of SF <sub>6</sub> (10 Hz release system) and propene (4 Hz release system) exhaust concentrations for 0405(a) and 0412(b).. .....  | 325                |
| 5.2.1.1.1                | Survey of bus cabin pressures using the “blower door” method. Note the first two digits of the bus number correspond to the model year. Black bars represent buses used in the main study.....  | 326                |
| 5.3.1                    | Backpressure measurements in psi for the six engine types tested in the exhaust leak experiment (n is the number of buses tested for each engine type). Standard deviations are provided for the Cummins 250 and Cat 3208 engines.. ..... | 38                 |
| 5.4.1.1.1(a)             | Time series of percent self-pollution for SF <sub>6</sub> and propene during mobile runs conducted on 0427 .....  | 410                |
| 5.4.1.1.1(b)             | Time series of percent self-pollution for SF <sub>6</sub> and propene during mobile runs conducted on 0504. ....  | 41                 |
| 5.4.1.1.1(c)             | Time series of percent self-pollution for SF <sub>6</sub> and propene during mobile runs conducted on 0510 .....  | 421                |
| 5.4.1.1.1(d)             | Time series of percent self-pollution for SF <sub>6</sub> and propene during mobile runs conducted on 0511 .....  | 42                 |
| 5.4.1.1.2                | Time series for SF <sub>6</sub> and propene concentrations on 0406. The bus was not flushed of tracer gas for these runs .....  | 43                 |
| 5.4.1.2.1                | Time series for percent exhaust intrusion by SF <sub>6</sub> and propene on 0412 (leader exhaust test) .....  | 45                 |

|                      |  |    |
|----------------------|--|----|
| <b>5.4.1.2.2</b>     | Time series for percent exhaust intrusion by SF <sub>6</sub> and propene on 0419 (leader exhaust test). .....  | 47 |
| <b>5.4.2.1.1</b>     | Time series for percent self-pollution by propene on 0427. The boxed areas represent runs where power ventilation was tested.....  | 47 |
| <b>5.4.2.2.1</b>     | Time series for percent exhaust intrusion by SF <sub>6</sub> on 0419 during a leader exhaust test. The boxed areas represent runs when power ventilation was tested.....     | 48 |
| <b>5.4.3.1.1</b>     | Time series of percent self-pollution for SF <sub>6</sub> and propene on 0510 examining the combination of exhaust position and blower operation as a mitigation measure. 51 |    |
| <b>5.4.3.1.2</b>     | Time series of percent self-pollution for SF <sub>6</sub> and propene on 0503 examining the combination of exhaust position and blower operation as a mitigation measure. 51 |    |
| <b>5.4.3.2.1</b>     | Time series of percent exhaust intrusion for SF <sub>6</sub> and propene during a leader exhaust run conducted on 0412.....  | 52 |
| <b>5.4.4.1</b>       | Average propene tracer gas concentrations (by exhaust position) in the bus cabin for windows sealed (0407) versus unsealed (0406).....                                       | 54 |
| <b>5.4.4.2</b>       | Time series for SF <sub>6</sub> and propene concentrations during window seal test on 0407 .....   | 54 |
| <b>5.5.1</b>         | Time series of percent self-pollution and exhaust intrusion for SF <sub>6</sub> and propene, respectively, during a leader exhaust-follower exhaust test on 0413 .....       | 56 |
| <b>5.5.2</b>         | Time series of percent self-pollution and exhaust intrusion for propene during a leader exhaust-follower exhaust test on 0420.....   | 56 |
| <b>5.6.1</b>         | School bus orientation in relation to wind direction for stationary self-pollution runs. ....  | 58 |
| <b>5.6.2</b>         | School bus orientation for leader exhaust testing. Both tracer gases are released from the leader bus from a high exhaust position and low exhaust position. ....            | 58 |
| <b>5.6.1.1(a, b)</b> | Time series for SF <sub>6</sub> and propene during stationary self-pollution testing on 0426 (a) and 0504 (b).....   | 61 |
| <b>5.6.1.1(c)</b>    | Time series for SF <sub>6</sub> and propene during stationary self-pollution testing on 0510 .....   | 62 |
| <b>5.6.2.1</b>       | Time series for SF <sub>6</sub> and propene during stationary exhaust intrusion runs conducted on 0413.....  | 66 |



|                |  |    |
|----------------|--|----|
| <b>5.6.2.2</b> | Time series for SF <sub>6</sub> and propene during stationary exhaust intrusion runs on 0420.....  | 66 |
| <b>5.7.1</b>   | SF <sub>6</sub> tracer gas exhaust concentrations (1-minute medians) for Bus 982/TO1 on run 0407 calculated using measured SF <sub>6</sub> and exhaust flow rates versus those calculated with constant 2 lpm SF <sub>6</sub> flow rate and measured exhaust flow rate.. | 70 |
| <b>5.7.2</b>   | Time series for 0406 run in current study and average self-pollution value (0.0275%) from our previous study.....  | 71 |
| <b>7.1</b>     | MapPoint locations where the speed was less than 10 dm/sec along Route 1 during a test run conducted on 4-20-05.   | 76 |
| <b>7.2</b>     | MapPoint locations of where the SF <sub>6</sub> was greater than 750 ppt along Route 1 during a test run conducted on 4-20-05.   | 77 |
| <b>7.3</b>     | MapPoint locations of SF <sub>6</sub> concentrations and speed along Route 1 during a test run conducted on 4-20-05.   | 77 |

## LIST OF TABLES

| <b><u>Table No.</u></b> | <b><u>Title</u></b>  | <b><u>Page</u></b> |
|-------------------------|--|--------------------|
| 1.1                     | Beneficial or negative effects of different mitigation methods under different run conditions.....   | 2                  |
| 2.4.2.2.1               | Results from ventilation test conducted in our previous study (Fitz et al., 2003) for selected buses.....  | 8                  |
| 3.2.4.1                 | SF <sub>6</sub> data (in ppt) for pilot study leader/follower test, evaluating effect of window position and exhaust position in a leader vehicle.....                                   | 12                 |
| 4.2.2.1                 | Measurement methods utilized in the main study.....  | 17                 |
| 4.2.4.3.2.1             | Flow, as measured by pressure in inches of H <sub>2</sub> O for split exhaust hardware including ratios for high versus low exhaust flow for each test bus.....                          | 23                 |
| 5.1.1                   | Characteristics of the test buses.....   | 28                 |
| 5.1.2                   | Description of all mobile runs (conducted in 2005). ....   | 29                 |
| 5.1.3                   | Meteorological data during mobile runs (with standard deviations) .....  | 30                 |
| 5.1.1.2.1               | Variation of SF <sub>6</sub> and propene exhaust concentrations for all mobile runs in the main study. SP=Self-Pollution, LE=Leader Exhaust, LE-FE=Leader Exhaust-Follower Exhaust. .... | 33                 |
| 5.4.1.1.1               | Percent self-pollution for individual runs examining the effect of the high exhaust position.....  | 42                 |
| 5.4.2.1.1               | Effect of power ventilation (tracer gases released from low exhaust position) on self-pollution.....   | 47                 |
| 5.4.3.1.1               | Percent self-pollution for individual runs examining the effect of the high exhaust position and blower operation mode.....  | 50                 |
| 5.4.3.1.2               | Percent self-pollution for individual runs examining the effect of high versus low exhaust position when the blower was in operation .....   | 50                 |
| 5.6.1                   | Description of all stationary runs (conducted in 2005).....  | 59                 |
| 5.6.2                   | Meteorological data during stationary runs (with standard deviations).....   | 60                 |
| 5.6.1.1                 | Average percent self-pollution (relative to low exhaust) and changes in self-  |                    |

|                   |   |    |
|-------------------|---|----|
|                   | pollution for individual stationary runs examining the effect of high versus low exhaust position. ....   | 62 |
| <b>5.6.1.2</b>    | Average percent self-pollution (relative to blower off) and changes in self pollution for individual stationary runs examining the effect of blower operation. ....   | 63 |
| <b>5.6.1.3(a)</b> | Average percent self-pollution (relative to low exhaust) for individual stationary runs examining the effect of high versus low exhaust position when the blower was in operation. ....   | 63 |
| <b>5.6.1.3(b)</b> | Average percent self-pollution (relative to blower off) and changes in self-pollution for individual stationary runs examining the effect of blower operation when the exhaust position was high.....   | 63 |
| <b>5.6.2.1</b>    | Average percent exhaust intrusion (relative to low exhaust) and percent change in exhaust intrusion from a leader bus measured in the follower bus during stationary leader exhaust runs examining the effect of high versus low exhaust position on a leader bus. ....   | 67 |
| <b>5.6.2.2</b>    | Average percent exhaust intrusion (relative to blower off) and percent change in exhaust intrusion from a leader bus measured in the follower bus during stationary leader exhaust runs examining the effectiveness of using the blower in the follower bus in preventing exhaust intrusion from the low exhaust position of the leader bus. ....                                   | 67 |
| <b>5.6.2.3(a)</b> | Average percent exhaust intrusion (relative to low exhaust) and percent change in exhaust intrusion from a leader bus measured in the follower bus during stationary leader exhaust runs examining the effectiveness of high versus low exhaust position on the leader bus in preventing exhaust intrusion in the follower bus while operating the blower in the follower bus. .... | 67 |
| <b>5.6.2.3(b)</b> | Average percent exhaust intrusion (relative to blower off) and change in percent exhaust intrusion from a leader bus measured in the follower bus during stationary leader exhaust runs examining the effectiveness of blower operation in the follower bus and high exhaust position on the leader bus in preventing exhaust intrusion on the follower bus. ....                   | 68 |

## LIST OF PHOTOGRAPHS

| <b>Photograph No.</b> | <b>Title</b>   | <b>Page</b> |
|-----------------------|--|-------------|
| 3.2.2.1               | A leak at the bottom of a bus door.....  | 10          |
| 4.2.4.1.1             | Backpressure method to evaluate exhaust system leaks using a silicon stopper and magnehelic.....   | 20          |
| 4.2.4.2.1             | Sealing passenger windows with plastic sheeting to assess contribution of window leaks to overall leaks on the bus.....  | 20          |
| 4.2.4.3.1.1(a, b)     | Tracer Gas Release System: (a) toggle switch to reverse tracer gas release position and (b) mass flow controllers to control tracer gas release into the tailpipe.....                             | 22          |
| 4.2.4.3.2.1           | Split exhaust configuration for self-pollution experiments. One tracer gas was released from each exhaust branch .....   | 22          |
| 4.2.4.3.2.2(a-d)      | Blower inlet positions on Bus 982 (a-b) and Bus 872 (c-d) .....  | 24          |
| 4.2.4.4.1             | Exhaust configuration for leader vehicle during leader exhaust tests to evaluate impact of following a bus with high versus low exhaust .....  | 25          |
| 4.2.4.4.2(a, b)       | Exhaust configurations for follower bus (a) and leader bus (b) during leader exhaust/follower exhaust tests to assess impact of exhaust intrusion from a leader vehicle versus self-pollution..... | 26          |

## ABSTRACT

“Self-pollution,” the intrusion of a bus’s own exhaust into the bus cabin, leads under some conditions to very high exposures. This study attempted to elucidate how and where self-pollution occurs, and to test various methods to mitigate this phenomenon. The mechanism of self-pollution was investigated by evaluating the magnitude of exhaust system leaks, searching for exhaust entry points using a tracer gas, and determining the overall leak rate of the bus cabin. Comprehensive detection of leaks in the exhaust system using SO<sub>2</sub> from the exhaust as a tracer gas and a survey of leak potential using back pressure measurements showed that exhaust system leaks in a well-maintained system were insignificant. However, identifying specific exhaust entry points into the passenger compartment using tracer gas was found to be infeasible due to the large number of potential entry points. To quantify overall air tightness of cabins, the leak rate of 17 buses was evaluated by pressurizing them with an air blower with a constant flow rate and measuring the pressure differential between the inside and outside of the bus (“blower door method”). Pressure differentials ranged over a factor of five, but in general, newer buses showed lower leak rates.

The primary self-pollution mitigation methods evaluated consisted of elevating the exhaust outlet, power ventilating the cabin, or a combination of the two methods. Because following other buses is also a major source of high bus cabin concentrations, these methods were evaluated for their efficacy in reducing not only self-pollution but also pollution from a leader bus. Comparisons were made both in stationary mode and while driving a prescribed route, using four test buses representative of the current in-use school bus fleet. Exhaust intrusion into the cabin was measured using a dual tracer gas approach to allow for a direct comparison between the mitigated and unmitigated scenarios. Two separate, non-interfering tracer gases were metered into the exhaust in proportion to engine intake flow rates to maintain near-constant tracer gas concentrations in the exhaust. Real-time analyzers were used to monitor the concentration of each tracer gas inside the cabin of the test bus. The concentration data were used to calculate the volumetric fraction of air inside the bus that originated from each tracer-labeled exhaust.

Evaluation of the high-exhaust mitigation strategy used a split exhaust (half of the flow released above the roof and half released at the normal low position) with a separate tracer gas metered into each half. When evaluating exhaust intrusion from a leader bus, both tracers were similarly released on a leader bus while measurements were taken on a follower bus. A second set of leader-follower experiments involved metering one tracer gas in the leader bus exhaust and metering the other tracer gas in the follower bus exhaust. This allowed comparing the magnitude of self-pollution versus exhaust intrusion from a leader vehicle. The effects of power ventilation were evaluated by comparing the above test outcomes with the blower on versus off. While results showed the blower reduced the exposure to self-pollution and leader-pollution most of the time, occasionally exhaust plumes reached the blower inlet at low speeds or during idling, causing high peak concentrations that largely negated the benefits of the power ventilation. Using an elevated exhaust outlet significantly reduced the exposure due to self-pollution, but resulted in only modest reductions in leader-vehicle pollution. Our overall recommendations are to employ elevated exhaust outlets on school buses and to minimize exposure to leader vehicle exhaust by avoiding close caravanning of diesel school buses.

## 1.0 EXECUTIVE SUMMARY

Background: Previous studies have shown “self-pollution” of school bus cabins is a significant source of pollutant exposure and the pollution from a leading diesel vehicle leads to even greater exposure. The objective of this study was to identify and evaluate reasonable feasible mitigation measures to reduce the exposure in the school bus micro-environment. The measures evaluated included the repair of exhaust system leaks, better sealing of the bus cabin, power ventilation of the bus cabin, raising the exhaust release point, and a combination of the last two methods.

Methods: Leaks in the exhaust system itself were evaluated by two approaches: probing with the inlet of a real-time sulfur dioxide detector and by inducing and measuring backpressure in the exhaust system. To identify tailpipe exhaust entry points in the bus cabin, SF<sub>6</sub> tracer gas was metered into the exhaust and a real-time SF<sub>6</sub> analyzer was used to probe for entry points. The overall cabin leak rate was evaluated by the blower door approach: pressurizing the bus with a blower with a constant flow rate and measuring the pressure differential between the inside and outside of the test bus. To measure self-pollution and leader-pollution, SF<sub>6</sub> and/or propene tracer gas was added to the exhaust of one or both vehicles, in both stationary and mobile modes. The follower or self-pollution test bus was equipped with real-time SF<sub>6</sub> and propene analyzers. The concentration data were used to calculate the volumetric fraction of air inside the bus that originated from the tracer-labeled exhaust (percent intrusion), which is the ratio between the concentration of tracer gas in the bus cabin and the concentration of tracer gas in the exhaust. The effectiveness of the raised exhaust position to mitigate pollutant intrusion was determined by adding exhaust piping to split the flow evenly between the normal bumper position outlet and a position above the bus body. SF<sub>6</sub> was metered to one path while propene was metered to the other. This approach allowed continuous comparison under identical conditions. The effectiveness of power ventilation to mitigate pollutant intrusion was determined by alternating tests with the blower on or off.

Results-Pilot Study: A pilot study utilizing a single instrumented test bus was conducted to demonstrate the study design feasibility. A real-time sulfur analyzer was used to probe for exhaust leaks on a single older bus (1985 Thomas Coach) using a sulfur-enhanced fuel. No significant leaks were found and the method was found to be impractical for testing a large number of buses, since sulfur needed to be added to the fuel. Probing the exterior of the bus while pressurizing the cabin using a blower whose output was dosed with propene indicated leaks were present throughout the bus. The blower output of 34 m<sup>3</sup>/min resulted in a pressure differential of 0.18 inches of water column, indicating widespread leakage. Individual leaks could not be pinpointed by adding tracer gas to the exhaust and probing the inside of the cabin due to ubiquitous leak locations which resulted in elevated concentrations throughout the cabin. Some leaks, however, allowed tracer-free ambient air to enter the cabin.

A tracer gas release system that varied the flow of tracer gas in relationship to the engine’s air processing flow rate to maintain a constant concentration in the exhaust was designed, built and evaluated. The initial leader-follower tests showed little difference between the high and low exhaust release points on the leader vehicle. We concluded a split exhaust system using separate tracers injected at each position was needed so that results could be compared directly.

The combined results of the pilot study suggested that the main study should focus on the mitigation measures of raising the exhaust and ventilating the cabin.

Main Study: Seventeen buses were screened for exhaust leaks using the backpressure

approach and for cabin “tightness” using the “blower door” approach, with a squirrel-cage blower mounted on the bus door opening to pressurize the bus. Using engine backpressure to evaluate exhaust leakage, leakage rates appeared to be dependent on the engine make and model. Six different engine types were employed. We concluded lower pressures within an engine make and model may be indicative of a leak, although physical examination did not indicate any buses had substantial exhaust leaks. The pressure drop for the “blower door” tightness test ranged from 0.04” to 0.25” of water column. Newer buses were generally tighter.

The mitigation measures of raising the exhaust outlet and power ventilating the cabin were evaluated using four different instrumented test buses covering a range of manufacturers and model years to be representative of those most commonly used in California. The four buses chosen for testing were a 1987 Blue Bird, a 1993 Carpenter SPT-3908, a 1998 Thomas Saf-T-Liner and a 2002 Thomas Saf-T-Liner. A total of 54 mobile test runs and 32 stationary (with the bus’s exhaust pointed into the wind) test runs were conducted. Table 1.1 summarizes the results for self-pollution and leader exhaust intrusion when the bus was on a test route (mobile) and when stationary. The high exhaust release location consistently reduced the amount of self-pollution. Using power ventilation gave less consistent results, and at times it appeared the test bus’s own exhaust was pulled into the blower inlet with relatively little dilution. This was particularly noticeable when the exhaust was discharged in the high position. Similar results, although of a more qualitative nature, were obtained for tracer added to the exhaust of a leading vehicle. Exhaust intrusion in the test follower bus from leader vehicles was typically twice that of self-pollution on the test bus.

**Table 1.1** Beneficial or negative effects of different mitigation methods under different run conditions. “++” (or “--”) indicates consistent and sizeable reductions (or increases) in exhaust intrusion; “+” (or “-”) indicates frequent but less sizeable increases (or decreases); and “+/-” indicates mixed effects with sometimes large increases in exhaust intrusion if “--” included.

| MITIGATION METHOD           | Exhaust High | Blower On  |             |
|-----------------------------|--------------|------------|-------------|
|                             |              | Blower Off | Exhaust Low |
| TEST CONDITION              |              |            |             |
| RUN TYPE                    |              |            |             |
| Self-Pollution, Mobile      | ++/-         | ++         | +/--        |
| Self-Pollution, Stationary  | ++/-         | +/--       | +/--        |
| Leader-Follower, Mobile     | +            | +/-        | -           |
| Leader-Follower, Stationary | ++           | +/--       | --          |

Conclusions: The blower door method was an effective method to determine the overall tightness of a bus and should be used as a diagnostic test to ensure tightness is maintained as buses age. Bus exhaust system leaks in well-maintained buses were found to be insignificant. Children’s exposure to exhaust, particularly from self-pollution could be significantly reduced by placing the exhaust outlet above the bus. Exhaust from a leading vehicle can be more significant than self-pollution and therefore close caravanning of school buses should be avoided, and buses should also avoid following other diesel-powered vehicles closely, further reinforcing this recommendation made in our previous school bus exposure study (Fitz et al., 2003). Results from the current study, however, are not directly comparable to our previous school bus study due to differences such as the time of day in which the tests were conducted, bus types, and routes.

## **2.0 INTRODUCTION AND BACKGROUND**

### **2.1 Introduction**

Children's health has been the focus of intense interest in California across all levels of government, as well as in academic research, the advocacy community, and Federal health and environmental agencies. California Senate Bill 25 (Escutia 1999) required the California Air Resources Board (ARB) to identify areas where exposure of infants and children to air pollutants were not adequately measured by the current fixed-site monitoring network and to conduct enhanced monitoring. Among the greatest concerns has been growing evidence of the impacts of air pollution on children's respiratory function and other health indicators. Children are especially susceptible to air pollution because of their high inhalation rates relative to body mass, high activity rates, greater time spent outdoors, narrower lung airways, immature immune systems and rapid growth (Lipsett, 1989; Pope, 1989; Phillips et al., 1991; Wiley et. al., 1991; U.S. EPA, 1996). The ARB has been particularly concerned with exposures resulting from the amount of time children spend during school bus commutes, since one million children are transported by public school buses each day (California Department of Education, 2002). About 70% of the 26,000 school buses in California remain powered by diesel engines (Long, 2000), which emit exhaust particulate the ARB has declared to be a Toxic Air Contaminant.

### **2.2 Background**

Concern about this issue led the ARB to fund a recently-completed study by the present research team, designed to characterize the range of children's pollutant exposure during school bus commutes (Fitz et al., 2003; Sabin et al., 2005a, b). Following a pilot study to demonstrate feasibility of the study design and measurement protocols, real-time and integrated measurements of a wide range of gaseous and particulate pollutants were conducted while driving several distinct school bus routes in Los Angeles with eight different school bus and fuel/emission control technology combinations. Across the pilot and main studies, three key microenvironments were investigated: bus stops, loading/unloading zones, and school bus interiors during commutes. It was shown that children's typical urban commute times were far more important as a determinant of exposure than typical times spent in either school loading/unloading zones or at bus stops (Behrentz et al., 2005).

The key variables affecting children's exposure on school buses were identified (Sabin et al., 2005a, b) and included the degree of exhaust intrusion ("self pollution"), window position, nearby diesel vehicles (especially other diesel school buses), and roadway type. Due to self pollution, directly emitted, vehicle-related pollutants such as black carbon and particle-bound, polycyclic aromatic hydrocarbons (PAHs) were higher with windows closed than open. In addition, these same pollutants were much higher on urban routes compared with a rural/suburban route (Sabin et al., 2005a). Additional findings were that higher exposures to pollutants such as nitrogen dioxide (NO<sub>2</sub>), benzene, 1,3-butadiene and a range of aldehydes and ketones occurred during children's commutes than indicated by measurements at nearby central sites.

High commute exposures resulted in part from expected causes, including the high concentrations of pollutants already present on roadways, especially in heavy traffic, and the direct influence of other vehicles being followed. A critical and novel finding from this ARB-sponsored study was that self-pollution could contribute as much to the high exposures that children experience during school bus commutes as the surrounding traffic itself. This phenomenon of self-pollution was unambiguously demonstrated through the use of a tracer gas, sulfur hexafluoride (SF<sub>6</sub>), injected



into the exhaust of each bus tested during commutes (Behrentz et al., 2004).

In general, higher concentrations of diesel-related pollutants (i.e., more than double) were observed when the windows were closed, and older buses had greater intrusion of their own exhaust into the cabin compared with newer buses. For conditions such as idling at bus stops with the wind coming from the rear, we observed SF<sub>6</sub> tracer gas outside at the front of the buses for all commutes although the mean concentrations were much lower than the SF<sub>6</sub> concentrations inside the bus.

The extent of self-pollution we identified through the tracer technique was dramatic: every bus we tested exhibited some degree of self-pollution during every bus commute. Moreover, about 25% of the variance in black carbon within-cabin concentrations could be explained by intrusion of the bus's own exhaust. In a sample calculation for one of the "representative" buses in our study, approximately half of the mean black carbon concentration during the one-hour commute could be accounted for by self-pollution.

Although this earlier investigation of children's exposure in school bus commute-related microenvironments appears to be the most definitive study of its kind, investigation of mitigation measures for "self-pollution" or "leader/follower" pollution was beyond the scope of that study. Therefore an investigation of the various mechanisms of intrusion of exhaust into school bus cabins, and feasible mitigation measures, was needed.

### 2.3 Statement of Problem

There are at least four possible mechanisms for exhaust gases to enter the cabin of school buses. First, leaks from the engine's compartment can enter into the cabin, possibly as the result of leaks in the exhaust train. Second, the exhaust plume exiting from the tailpipe can travel from the rear of the bus and enter the cabin through the windows (if open, or perhaps when closed as well) or through other entry points in the cabin. Third, the exhaust from a "leader" vehicle can enter the cabin of a following bus through windows or the cabin. Fourth, crankcase emissions can also enter the bus cabin; however at the time of this study, crankcase emissions were not recognized as an important source of self-pollution. While it was beyond the scope and resources of our previous study to directly investigate any of these mechanisms in detail, the results conclusively demonstrated the importance of self-pollution due to the intrusion of tailpipe exhaust into the bus cabin (Behrentz et al., 2004) and the impacts of leader vehicle exhaust, especially the exhaust of other diesel vehicles (Sabin et al., 2005a, b).

In our previous project report (Fitz et al., 2003), we made a number of policy recommendations designed to mitigate the impacts of exhaust from diesel vehicles being followed by a school bus. For example, we recommended reducing or eliminating the "caravanning" of buses (presently a common practice) and attempting to minimize following other heavy-duty diesel vehicles. However, we could not recommend or design specific mitigation measures for "self-pollution" and "leader/follower" pollution without a thorough investigation of the mechanisms of these phenomena.

### 2.4 Previous Vehicle Exhaust Intrusion Studies

Chan et al. (1991) determined the penetration of volatile organic compounds (VOC), carbon monoxide (CO), and NO<sub>2</sub> from a car's exterior into the car's cabin by simultaneously measuring the pollutants inside and outside of two experimental vehicles. The median inside/outside ratio was approximately 1.1 for the three pollutants, suggesting a slight but measurable contribution of tailpipe and engine running loss emissions into the passenger compartment. In-vehicle VOC concentrations were lower with the air conditioner on and higher when the vent was open with the fan on.

Fletcher and Saunders (1994) determined the infiltration rate of a gas into stationary motor

vehicles for different wind speeds and directions. Measurements were made on five vehicles under both positive and negative pressures to determine their leak characteristics. A tracer gas method was then used to determine the air exchange rates in the vehicles for different wind speeds and directions. Measurement of air exchanges per hour were also made on a vehicle driven at constant speed and while moving through a cloud of contaminant.

Clifford et al. (1997) analyzed the local aspects of vehicular pollution using 1:10 scale models placed in a low-velocity wind tunnel with tracer gases (SF<sub>6</sub> and nitrous oxide) injected into the airflow. Measurements showed the exhaust gases are entrained in the wake of the vehicle from which they are emitted, and are dispersed mainly by the movement of such wakes. Thus, the wake itself may be a self-pollution source, depending on its contact with the bus and its pressure relative to the bus interior.

Wu et al. (1998) reported the use of an iridium tracer to determine soot exposure of high school students commuting to and from school in passenger cars, and on diesel public transit buses in Baltimore. During this study a portion of the Baltimore municipal fuel supply was tagged with iridium traces and exposure was monitored during commutes with personal aerosol monitors. The tracer was undetectable in personal samples collected by the students commuting in passenger cars when the windows were closed, but comparable to the samples collected on transit buses when the vehicle windows were open during the commute.

Chan et al. (2000) evaluated in-vehicle and out-vehicle CO concentrations during different driving microenvironments including tunnels and highways. In-vehicle CO levels were highest in urban residential, rural districts and on some highways; varied with different land uses; and were found to be influenced by pollutant levels outside the vehicle. The results suggested the penetration of emissions from outside sources, (through leaks, joints, or the ventilation system) were occurring during commutes.

Behrentz et al. (2004) developed a method to evaluate the fraction of a bus's own exhaust that entered the cabin of several in-use school buses over a range of roadway types, fuels, and emission control technologies. The percentage of intrusion of the bus's own exhaust into the cabin, or self-pollution, was found to be a function of bus type, age, and window position (i.e., open or closed). Older buses exhibited a larger amount of self-pollution compared to newer buses with up to 0.3% of the bus's own exhaust entering the cabin. Also, 25% of the within-cabin black carbon concentration variance could be explained by the buses' self pollution. For all buses tested, the amount of self-pollution was highest while windows were closed compared to when windows were open.

Fitz et al. (2003) evaluated the impact of a leader bus on a follower bus (with windows open) using tracer gas released into the exhaust of the leader and driving the same route that we describe as Route 1 later in this report. The concentration of tracer gas was found to be approximately five times higher than when the tracer gas was released from the follower bus (self-pollution) in separate test runs using this route.

#### 2.4.1 Mechanisms of Exhaust Intrusion Studies

Although several studies on exhaust intrusion have been conducted, there have been far fewer studies conducted that have evaluated *mechanisms* of exhaust intrusion.

In 1981, Ziskind et al. conducted a study investigating the intrusion of carbon monoxide (CO) into sustained-use vehicles. These vehicles included taxicabs, police cruisers, and school buses. The main sources of CO were from leaks at the rear of the exhaust system or from tailpipe exhaust. In vehicles with excessive interior CO levels, the sources and intrusion pathways were identified using a sulfur SF<sub>6</sub> detection system. For school buses, large leaks were most often

observed at the rear emergency exit door seal, heater or windshield washer water hoses, and along the exhaust system. The study also found the greatest potential for CO accumulation occurred when vehicle windows, doors, and vents were closed.

## 2.4.2 Other Related Exhaust Intrusion Studies

### 2.4.2.1 Ventilation Air Flow Patterns Inside Vehicles

The ASHRAE applications handbook (1999) discusses how to optimize the air-flow within the cabin of a bus. The handbook states it is necessary to position air inlets and outlets based on the pressure gradient distribution in the cabin. Most of the pressure is positive on the front surface with the stagnation point located at about 1/3 of the height of the bus. The pressure is strongly negative at the top and side leading edges, due to localized high velocities. Behind the recirculation bubble in the front, the pressure on the roof is nearly zero and in the rear, the pressure coefficient is always slightly negative. Thus, the best location for inlets is the lower part of the front surface. The areas with strong negative pressure coefficients in the side panels just behind the front are the best locations for the outlets because vehicle movement drives the flow.

A number of workers have studied flow distribution within vehicles using tracers. For example, Komoriya (1989) used kerosene smoke to study the effect of air changes per hour (ACH) on the conditions inside a vehicle compartment and demonstrated that a numerical method could be used to qualitatively simulate ventilation experiments.

Ishihara et al. (1991) determined the flow velocity distribution inside a vehicle by combining a particle-tracking technique with a pulsed-laser-light-sheet technique. By using a 1:4 scale vehicle model and water as the flow medium, flow velocity distributions were determined. Lasers were directed toward the flow to visualize paths of distinctive particles. The authors suggested that a similar methodology could be used to measure flows from the exhaust system into the cabin and external flows around the vehicle body, although neither of these topics was investigated in that study.

Conceicao et al. (1997a) installed a “removal” duct in a commuter bus to improve ventilation rate and modeled the airflow with a simple, uni-dimensional flow model, predicting the air exchange rate as a function of the vehicle velocity. In addition, tracer gas experiments were performed to demonstrate the adequacy of the model and the efficacy of an air removal duct. Conceicao et al. (1997b) also mapped the flow field of the zone occupied by passengers, in terms of mean air velocity, turbulence intensity, and temperature. A full-scale bus section was used in the laboratory tests, with the passenger presence simulated by thermally-regulated mannequins. Measurements were performed with and without “passengers” seated in the windows seat and in the aisle seat. Air velocity and turbulence in the vehicle were not affected by the presence of passengers, but did increase temperatures for certain test conditions when passengers were in the vehicle.

Lee et al. (1998) measured, simultaneously, the temperature and velocity field variations of the ventilation flow inside a vehicle cabin by using a digital image processing technique. In this study, micro-encapsulated TLC (thermochromic liquid crystal) particles were also used as a tracer for temperature and velocity measurement inside a 1/10 scale vehicle. The measured temperature and velocity fields exhibited a close relationship and a high degree of correlation. The simultaneous use of the two techniques can give reliable information on ventilation flow in the passenger compartment.

Aroussi and Aghil (2001) investigated the ventilation flow inside a 1:5 scale model of a typical mid-size passenger compartment with a driver present. Water was used as the fluid medium seeded with neutrally buoyant particle tracers. The fluid measurements used a particle image

velocimetry technique to acquire the velocity distribution. The prediction of velocity distributions showed this methodology could be useful for studying ventilation performance.

Oshio et al. (2001) studied the pressure levels observed in the ventilation ducts by making modifications to the ventilation system to understand how the shape and configuration of the air ventilation system determines the ventilation performance in a vehicle. These methods were able to predict the ventilation characteristics without the use of vehicle prototypes (passenger cars).

#### 2.4.2.2 Air Exchange Rate Studies

Air exchange rate (AER) can play a significant role in determining the magnitude of self-pollution. A number of studies have reported measured AERs for a wide variety of vehicles and conditions, and have found in general that AER is a strong function of vehicle speed and is much higher if windows are open.

During a study to measure the exposure to emissions from gasoline within automobile cabins, Weisel et al. (1992) showed the concentration of volatile organic compounds (VOC) inside the cabin of vehicles being driven on a suburban route in New Jersey, and on a commute to New York City, were inversely related to driving speed and wind speed relative to roadway air, although wind direction was not considered.

Ott et al. (1992) measured the air exchange rate, or air changes per hour (ACH), of an automobile (station wagon) moving at 20 miles per hour, and reported ACHs of  $13 \text{ h}^{-1}$  for windows closed and  $121 \text{ h}^{-1}$  for windows open. The ACH was calculated using a box mass balance model that is generally defined by the following relationship:

$$\partial Q = (1 - F)qC_{out}\partial t - qC_{in}\partial t - kQ\partial t + S\partial t \quad (2.1)$$

where Q is the mass of indoor contaminant; F is the fraction of the contaminant removed from the entering air; q is the volumetric air flow rate in and out the automobile; V is the interior volume of the automobile; t is the time; k is the rate of decay, settling, and removal; S represents the emissions from the internal source;  $C_{out}$  is the contaminant outside concentration; and  $C_{in}$  is the contaminant within-vehicle concentration.

Using carbon dioxide ( $\text{CO}_2$ ) as the tracer gas, Park et al. (1998) measured ACHs under four different wind conditions and four ventilation situations in three stationary vehicles. The initial  $\text{CO}_2$  concentration was approximately 3000 ppm at the start of each test run and the decay in  $\text{CO}_2$  concentrations was used to calculate the ACH, which ranged between  $1.0$  and  $3.0 \text{ h}^{-1}$  with windows closed and no mechanical ventilation to  $36$  and  $48 \text{ h}^{-1}$  for windows closed with the fan set on fresh air. ACHs for windows closed with no mechanical ventilation were higher for older automobiles than for newer vehicles. This study only used stationary vehicles since idling is a major component of a typical commute in heavy-traffic urban areas.

Brauer et al. (2000) estimated average ACHs, using CO as an internal tracer gas, in two buses being driven in urban British Columbia during real school bus runs while under normal occupancy loads. ACHs ranged between  $10.3 \text{ h}^{-1}$  and  $13.5 \text{ h}^{-1}$  for two buses tested with windows closed while on the bus route.

In our previous study, Fitz et al. (2003), we measured air exchange rates with the windows open and the windows closed in seven different buses at speeds of 0, 20, and 40 mph. Air exchange rates inside the buses were measured by releasing an  $\text{SF}_6$  tracer gas inside the cabin and monitoring the gas concentration over time. The results of the ventilation tests are presented in Table 2.4.2.2.1, which shows the time constant, or the time required for 63% of the bus air to be exchanged. The

time for essentially complete exchange is three times (i.e. 95% exchange) to five times (i.e. 99% exchange) longer with windows closed versus windows open; the shorter the time for air to exchange, the higher the ventilation rate.

**Table 2.4.2.2.1** Results from ventilation test conducted in our previous study (Fitz et al., 2003) for selected buses.

| BUS                   | HE3           | RE1           | TO1           | CNG           |
|-----------------------|---------------|---------------|---------------|---------------|
|                       | Response Time | Response Time | Response Time | Response Time |
| TEST CONDITION        | (mm:ss)       | (mm:ss)       | (mm:ss)       | (mm:ss)       |
| Windows closed 0 mph  | 09:47         | > 30 min      | > 15 min      | > 42 min      |
| Windows open 0 mph    | 03:16         | 03:57         | 02:18         | 07:00         |
| Windows closed 20 mph | 01:52         | 01:56         | 04:38         | 02:00         |
| Windows closed 40 mph | 00:38         | 01:05         | 01:22         | 01:21         |
| Windows open 20 mph   | 00:58         | 00:48         | 00:23         | 00:26         |
| Windows open 40 mph   | 00:29         | 00:17         | 00:12         | 00:23         |

## 2.5 Objectives

### 2.5.1 Overall Objectives

The overall objectives of this study were to determine mechanisms of exhaust intrusion into school buses, and determine methods to economically reduce children’s pollutant exposure during school bus commutes.

### 2.5.2 Specific Objectives

#### 2.5.2.1 Pilot Study

The objectives of the pilot study were to:

1. Determine a method to systematically characterize school bus exhaust system leaks.
2. Identify and characterize intrusion mechanisms and locations for the bus’s own exhaust.
3. Determine the intrusion potential of the exhaust from a vehicle being followed.
4. Evaluate the effectiveness of changes in ventilation and exhaust hardware in reducing exhaust intrusion into the bus.

#### 2.5.2.2 Main Study

The objectives of the main study were to:

1. Determine a method to rapidly evaluate exhaust system leaks and survey a number of buses to characterize exhaust leaks.
2. Determine a method to rapidly evaluate bus cabin sealing and survey a number of buses to characterize cabin leak potential.
3. Evaluate the effectiveness of raising the exhaust outlet to a high position in reducing self-pollution and pollution from a leading vehicle with a high exhaust.
4. Evaluate the effectiveness of a centrifugal blower (i.e., power ventilation) in reducing self-pollution and pollution from a leading vehicle.

## **3.0 PILOT STUDY FINDINGS AND RECOMMENDATIONS**

### **3.1 Introduction**

The pilot study was conducted to develop effective investigative methods since little specific and relevant background information was available. All testing was conducted using a 1985 Thomas Coach, an 84-passenger school bus currently in use by a school district, and studied in our previous school bus study. The main study used the methods developed during the pilot study on a wider variety of buses.

### **3.2 Summary of Pilot Study Findings**

For the pilot study, we conducted four experiments: evaluation of exhaust system leaks; evaluation of leak points in the bus cabin (for self-pollution); testing of a tracer gas release system to help better quantify self-pollution; and evaluation of a leader vehicle. Further detail is found in Fitz et al. (2004).

#### **3.2.1 Evaluation of Exhaust System Leaks**

A Meloy SA 285 real-time SO<sub>2</sub> (sulfur dioxide) analyzer was used to probe for leaks in the bus exhaust system. The bus's fuel was spiked to 1000 ppm using an organic sulfide blend. Three small leaks were found in the pilot study bus. By probing an artificial SO<sub>2</sub> leak of known leak rate, we were able to quantify the leaks in the exhaust system as being in the range of 50 ml/min. This leak rate would represent less than 0.01% of the exhaust flow at idle. Based on these results, and the close proximity of the leaks to the exhaust outlet (2 meters), exhaust leaks in a well-maintained system (such as in the pilot study bus) were considered to be insignificant contributors to self pollution compared to exhaust rates from the tailpipe.

While gross exhaust leaks could be identified by traditional methods (visible carbon residue streaking, noise of escaping gas), it was difficult to evaluate the magnitude of such leaks. Although in principle, leaks could be quantified by this SO<sub>2</sub> method, it was not a practical method for surveying a large number of buses, primarily because it was necessary to add significant organic sulfur to the fuel (buses are routinely operated on low- or non-sulfur fuel and may have exhaust system catalysts that are poisoned by sulfur) to make quantitative measurements.

#### **3.2.2 Evaluation of Leak Points in the Passenger Cabin and Exhaust Intrusion**

The potential for exhaust intrusion into the bus's cabin was evaluated in two steps. First, we determined the location of leaks along the outside of the bus's cabin using propene tracer gas while the bus was stationary (engine off) and windows were closed. Tracer gas was introduced into a blower used to pressurize the bus cabin. A PID (photoionization detector) instrument was then used to search for leaks on the exterior of the bus. Leaks were found all over the bus, particularly around the windows and the front door. An example of a door leak is shown in Photograph 3.2.2.1. This amount of leakage eliminated the possibility of significantly reducing self-pollution by sealing the bus cabin.



**Photograph 3.2.2.1** A leak at the bottom of a bus door.

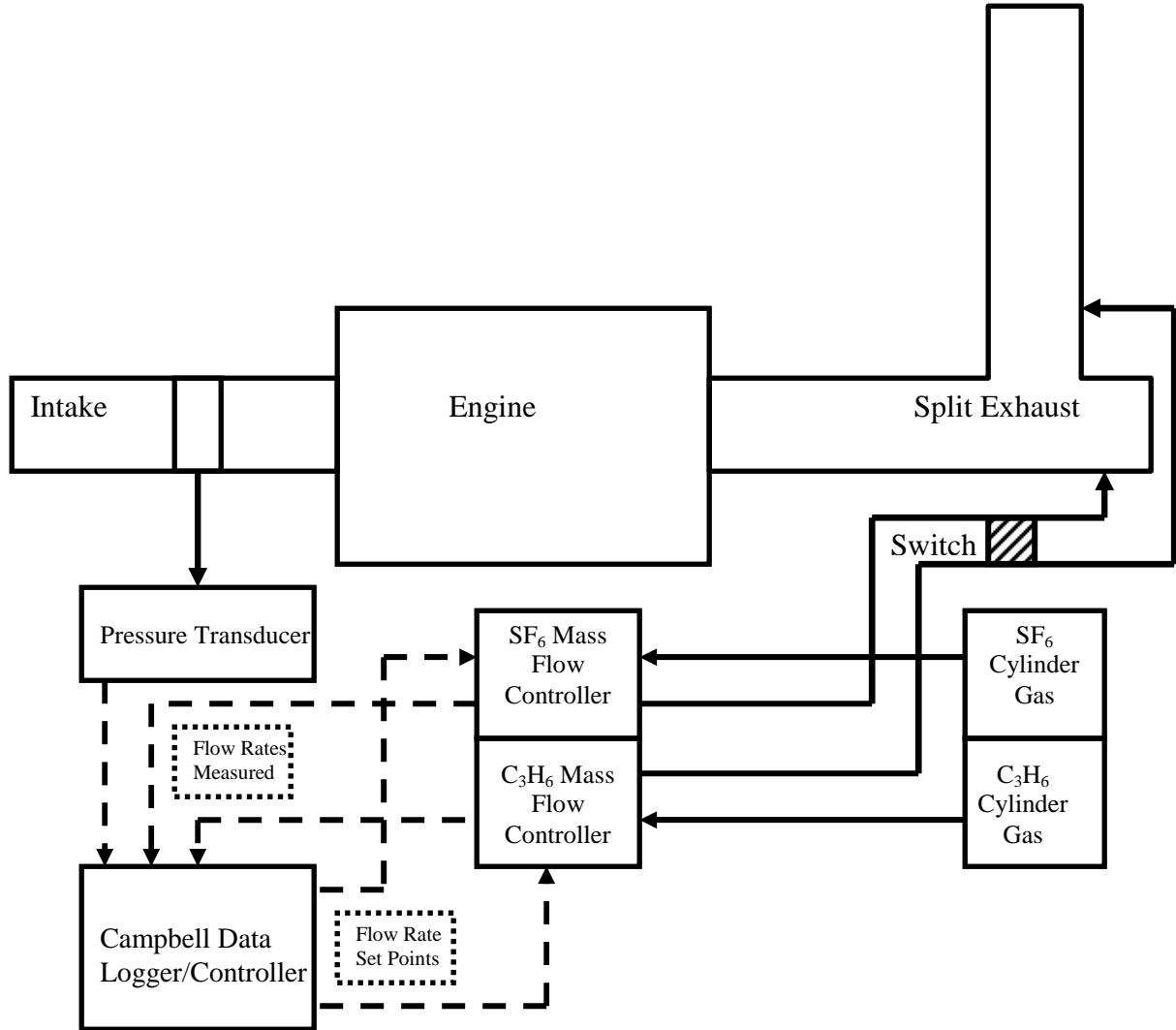
We determined that the overall leak rate for the pilot study bus was  $34 \text{ m}^3/\text{min}$  at a pressure differential of 0.18 inches of water column.

The second step to evaluate exhaust intrusion into the bus's cabin was to determine the location and magnitude of intrusion points using a tracer gas injected into the test bus's exhaust and measuring tracer gas in the bus cabin at potential leak points while both stationary and mobile. For the stationary test, the bus was parked so the tailpipe was upwind of the cabin.

Windows were closed for both the stationary and mobile tests. The  $\text{SF}_6$  release system as discussed in the next section (Section 3.2.3) was utilized in both tests to maintain a constant concentration of tracer gas in the bus's exhaust. We were unable to pinpoint leak locations within the cabin due to elevated and variable tracer gas concentrations found throughout the cabin. This was likely due to numerous gross leak points all over the bus as found in the first test, and a rapid overall accumulation of tracer due to self-pollution.

### 3.2.3 SF<sub>6</sub> Tracer Gas Release System

A schematic of the tracer gas release system employed in the pilot (and main) study is illustrated in Figure 3.2.3.1.



**Figure 3.2.3.1** Tracer gas release system used in main study, using two tracer gases. The system was controlled by engine intake flow.

Note the figure shows the use of two tracer gases. A 1% SF<sub>6</sub> cylinder was used for the pilot study. We used the remainder of the contents of the 1% SF<sub>6</sub> cylinder for the first runs of the main study then switched to a 5% SF<sub>6</sub> cylinder for the remainder of the main study runs. A second tracer gas (propene) was added in the main study as discussed in Section 4.2.4.3.1. For the pilot study, SF<sub>6</sub> alone was used in the release system.

The purpose of the release system was to maintain a constant concentration of the tracer gas in the exhaust to more accurately quantify self-pollution. First, we determined the pilot bus's exhaust flow by approximating exhaust flow with engine air intake flow. Second, based on the



intake flow, a mass flow controller was adjusted to release the appropriate amount of tracer gas into the tailpipe as to maintain a constant concentration of tracer gas in the exhaust. This method was evaluated while stationary (with varying rpm) and while traveling on a test route by measuring the concentration of SF<sub>6</sub> tracer gas directly from the exhaust.

The initial tracer gas release system worked well in achieving a relatively constant concentration in the bus’s exhaust while stationary or at steady speeds. During the stationary testing we found that there was a delay in the mass flow controller’s response in metering the correct amount of tracer gas into the exhaust. When the bus had a change in the exhaust flow rate, there was a one second delay before the mass flow meter received the updated set point information. This was because the controller operated at 1 Hz. Speeding the controller up to 10 Hz was sufficient to solve this problem.

### 3.2.4 Evaluation of Leader Vehicle Exhaust Intrusion

Exhaust intrusion from a leader vehicle was studied with the bus windows open and closed, and a tracer gas (SF<sub>6</sub>) released from the leader vehicle, a small moving truck. SF<sub>6</sub> was released either 0.5 m above the ground (low exhaust) or 0.5 m above the height of the leader vehicle (high exhaust). Four runs were conducted around the UCR campus (Route 1). For this combination of buses, exhaust position did appear to have somewhat of an effect on in-cabin concentrations of SF<sub>6</sub>, which originated from the leader vehicle when windows were closed. Window position also appeared to have an effect on in-cabin SF<sub>6</sub> concentrations with higher concentrations observed when windows were open. Results for this test are shown in Table 3.2.4.1. This experiment showed a second, different tracer needed to be released simultaneously at the other exhaust position to properly assess the impact of exhaust position due to variability between runs. A second tracer was utilized in the main study.

**Table 3.2.4.1** Mean SF<sub>6</sub> data (in ppt) for pilot study leader/follower test, evaluating effect of window position and exhaust position in a leader vehicle.

| Exhaust Position<br>Leader Bus | Window Position<br>Follower Bus |               |
|--------------------------------|---------------------------------|---------------|
|                                | <i>Open</i>                     | <i>Closed</i> |
| <i>High</i>                    | 3200                            | 2800          |
| <i>Low</i>                     | 3000                            | 3400          |

### 3.2.5 Evaluation of Proposed Mitigation Strategies

The mitigation methods we proposed included repairing exhaust leaks, sealing leaks in the bus cabin, improving bus cabin ventilation, pressurizing the cabin, and raising the exhaust outlet so it extended above the height of the bus. As noted above, exhaust system leaks were shown to be insignificant in our pilot study test bus. Cabin leaks were found to be too extensive to seal and it was not clear indiscriminate and incomplete sealing would be useful. Some of the leaks were so large they allowed significant amounts outside air to enter the cabin, improving cabin ventilation and causing tracer gas concentrations to decrease near these leak points in the cabin, especially while moving.

### 3.3 Modifications of Experimental Design for Main Study

As noted, the purpose of the pilot study was to develop methods to test mitigation strategies for reducing exposure to be used in the main study. Over the course of the pilot study, some methods proved to be time consuming or inadequate and modifications were needed. Based on our observations in the pilot study, several recommendations were made for the main study:

- We recommended the first bus of the main study be reasonably representative of California's school bus fleet, and that this first bus be used to further evaluate and refine all test procedures before testing additional buses. This was important to ensure the quality of the data collected from subsequent buses.
- The method for evaluating exhaust system leaks with a tracer gas proved to be too cumbersome considering the small impact exhaust leaks had on self-pollution. A more convenient method was needed to survey exhaust system leaks. We subsequently developed and employed a backpressure method for this purpose as described in Section 4.2.4.1.
- A straightforward and fairly rapid procedure needed to be developed to test *overall* bus leak rates due to the difficulty we found in the pilot study of isolating individual leaks in the cabin (in the main study no attempts were made to pinpoint individual leaks in the cabin). Development of this procedure would also allow for a survey of overall leak rates in buses in the in-use fleet from which we were recruiting test buses. To accomplish this task a centrifugal blower and the methods described in Section 4.2.4.2 were used.
- Improvements in the SF<sub>6</sub> tracer release system were needed for the main study. This was accomplished largely by changing the recording and speeding up the control rate of the data logger.
- The precision of both SF<sub>6</sub> and hydrocarbon analyzers needed to be fully documented.
- Methods and testing for mitigation measures were focused on raising the exhaust outlet for both the test and leader vehicles, and increasing the ventilation rate from front to rear using a blower and/or establishing a positive pressure in the bus cabin. When evaluating raised exhaust, we recommended the exhaust be evenly split between upper and lower outlet locations in a "T" shape, with SF<sub>6</sub> injected in one outlet and propene in the other, alternating the two tracers between bus commutes over the test route (see Section 4.2.4.3.2).
- Meteorological guidelines under which to conduct tests, especially wind speed, needed to be established to control for meteorological effects.

## **4.0 EXPERIMENTAL METHODS AND STUDY DESIGN**

### **4.1 Introduction**

This study was designed to identify cost-effective methods to reduce exhaust pollutant concentrations in the passenger cabin of school buses by evaluating routes of pollutant intrusion and methods for reducing such intrusions. The assessment strategy consisted of the following:

1. Development and documentation of a rapid method for the identification and ranking of exhaust leaks between the engine and the tailpipe (i.e., leaks in the exhaust system) and a survey of exhaust system leaks in buses within a district's fleet.
2. Development and documentation of a rapid method for the identification and ranking of the leak potential of a bus's cabin and a survey of buses within a district's fleet.
3. Evaluation of the effectiveness of mitigation measures such as raising the exhaust outlet and/or use of power ventilation in the bus's cabin in reducing self-pollution, for both stationary and mobile configurations, including driving under realistic traffic conditions.
4. Performance of leader/follower experiments in both stationary and mobile configurations and includes driving conditions to evaluate the effectiveness of mitigation measures such as high exhaust in the leader vehicle or power ventilation in the follower vehicle.
5. Providing a robust data set and distinguishing spatial and temporal factors contributing to in-cabin pollution, two different tracer gases and one to three tracer gas analyzers for each of these two tracer gases were utilized simultaneously during the driving tests.

#### **4.1.1 Vehicle Selection**

This study called for the use of 4-8 school buses. The exact number was subsequently determined by the effort needed to fully evaluate mitigation methods after testing the first bus. The goal was to utilize buses found to be representative of California's current bus fleet. In our previous study (Fitz et al., 2003), a 1999 California motor vehicle database was used to plot the distribution of buses by model year and manufacturer to aid in bus selection. One bus was chosen to be representative of older vehicles. The other three buses were chosen to represent both the ends and the middle of the distribution in the most recent 15 model years. When appropriate, buses from this previous study were used or additional buses were recruited from the same school district. If available, we chose Thomas and Blue Bird manufacturers since they accounted for approximately 35% of the fleet in southern California. After these vehicles were obtained and prepared, the monitoring instrumentation was installed in the bus on plywood sheets in a manner similar to that used in our earlier study.

#### **4.1.2 Fuel Used in the Test Buses**

The fuel used in all diesel buses tested (except for the leader bus) was Arco Emission Control Diesel (ECD-1). This fuel, or "green" diesel, has ultra-low sulfur content (<15ppm), low aromatics, and a high cetane number. Ultra-low sulfur fuel must be used for after-treatment emissions control technologies (e.g. particle trap catalysts) to function properly. The leader bus used diesel fuel meeting California regulations for sulfur in fuel (<500 ppm).

#### **4.1.3 Characterization and Justification of Selection of Test Routes**

The two routes described below were selected based on relative traffic density. Route 1 had relatively low traffic density and fewer stoplights and stop signs, a desirable characteristic for the leader/follower experiments, where the focus was evaluating the impact of the leader vehicle. Route

2 was characterized by increased traffic density and several stoplights and stop signs, conditions that would promote self-pollution.

#### 4.1.3.1 Route 1

Route 1, mapped in Figure 4.1.3.1.1 was utilized in all leader/follower runs and was also used for all runs in the pilot study. The start point was the intersection of Spruce Street and Iowa Avenue in the city of Riverside. The route traveled east on Spruce Street to Watkins Drive then southeast on Watkins Drive to State Highway 60, where the street name changed to Central Avenue, and then curved to the southeast. At Chicago Avenue a right turn was made and the route continued north to Spruce Street, where another right turn was made. The route was mostly free of other diesel-powered vehicles, which was optimum for our leader/follower tests, in order to better evaluate the effect of the leader bus only. The total length of the test route was approximately 10 miles and required 20-25 minutes to complete depending on traffic signals and congestion, which was generally light depending on the time of day. During morning and afternoon commutes, congestion added 10-15 minutes to the driving time.



Figure 4.1.3.1.1 Map of Route 1 in Riverside, California.

#### 4.1.3.2 Route 2

Route 2, mapped in Figure 4.1.3.2.1 was utilized in all self-pollution runs. The route began at the intersection of Market and 3<sup>rd</sup> Streets in downtown Riverside, then headed south on Market Street, which changed its street name to Magnolia Avenue. At Central Avenue a left turn was made, and the route headed east toward Riverside Avenue. A left turn was made at Riverside Avenue and another left at Jurupa Blvd. At Magnolia a right turn was made and the route headed back north toward 3<sup>rd</sup> Street. This route was characterized by moderate to heavy traffic with several stops (e.g. for stop lights, train tracks, or stop signs), creating conditions to promote self-pollution, for example, the exhaust plume of the bus being blown over the bus when stopping. The route was about 8-10 miles long taking approximately 30 minutes to complete a single loop. For the first 8 runs conducted in this study, Route 2 included a residential area. This section of the run was cut for all subsequent runs conducted on Route 2. Figure 4.1.3.2.1 does not include this residential area.



**Figure 4.1.3.2.1** Map of Route 2 in downtown Riverside, California.

### 4.2 Field Sampling Procedures

#### 4.2.1 Instrument Packaging and Supply

Power for all vehicle-mounted instruments was provided by 12V automotive batteries. A sine wave inverter was used to generate 110VAC for the instruments requiring AC power.

#### 4.2.2 Instrumentation

Table 4.2.2.1 summarizes the measurement methods used in the main study. This section provides detail on these methods and their purpose.

Concurrent with the preparation of the school buses, measurement instruments were assembled, configured, and tested at University of California, Riverside's College of Engineering, Center for Environmental Research and Technology, including all necessary calibration and data logging equipment. The instruments were tested for proper operation and proper interfacing with their respective calibration and data logging systems. After these tests were successfully completed, the instruments were installed in the bus and further tested.

**Table 4.2.2.1** Measurement methods utilized in the main study.

| Species/Measurement                          | Instrument/Model                | Detection Limit            |
|--|---------------------------------|----------------------------|
| Sulfur Hexafluoride (SF <sub>6</sub> )       | AeroVironment CTA 1000          | 10 ppt                     |
| Particle Bound PAH (inside and outside bus)  | EcoChem PAS 2000                | 0.01 µg/m <sup>3</sup>     |
| Particulate Matter Number>7nm                | Thermo Systems Inc. Model 3022  | 1 particle/cm <sup>3</sup> |
| Total Hydrocarbons                           | ppb RAE                         | 0.05ppm                    |
| Bus Location                                 | Garmin Map 76 GPS               | 3 m                        |
| Bus Engine rpm                               | Engine Alternator Signal        | Single pulse               |
| Temperature & Relative Humidity (inside bus) | Rotronics PM101A                | 0.5°C/5% RH                |
| Exhaust Gas Flow Rate                        | Omega PX274 Pressure Transducer | 0.00" H <sub>2</sub> O     |
| Wind Speed, Wind Direction, and Temperature  | Climatronics F460               | 0.1 m/s, 2 deg WD, 0.1°C   |

##### 4.2.2.1 SF<sub>6</sub> Measurements

SF<sub>6</sub> (sulfur hexafluoride), one of the tracer gases used in the main study and also used in the pilot study, was measured with two AeroVironment Model CTA 1000 analyzers. This instrument uses electron capture detection after water and oxygen are removed from the sampled air. The instrument was developed for operation on a moving platform and had a sensitivity of approximately 10 ppt with a response time of twenty seconds.

##### 4.2.2.2 Real-Time Particle Phase PAH Measurements

Two EcoChem Model PAS 2000 analyzers were used to measure concentrations of particle-bound PAH inside the cabin and outside the cabin (roadway concentrations). This instrument uses a UV lamp to photoionize PAH components of particles. An electric field is then applied to remove negatively charged particles. The positively charged particles are collected on a filter and the total charge collected is measured with an electrometer; the charge collected is proportional to the concentration of particle-bound PAH. The sensitivity of the instrument is approximately 10 ng/m<sup>3</sup>.

#### 4.2.2.3 Condensation Particle Counts (CPC)

A Thermo Systems Incorporated Model 3022 Condensation Particle Counter was used to determine the number concentration of particles. This device uses butanol to grow particles and light scattering to detect them. It detects particulates starting at 3 nanometers in diameter with the measurement efficiency increasing with size (50% of particles 7 nanometers in diameter) at concentrations up to  $10^7$  particles/cc. The response time is 13 seconds for a 95% response to a step change.

#### 4.2.2.4 Bus Location

Location was monitored with a Garmin GPS Map76 global positioning system with WAAS (Wide Area Augmentation System) capability. Position was determined to within three meters. In addition to horizontal position (e.g., latitude and longitude or UTM coordinates), the system also provided elevation and bus velocity data. These data were displayed on a liquid crystal display on the GPS with a digital output (RS232) for data logging along with the air quality data. The GPS unit was used as the time reference during this study. The clocks on all other devices were set to the GPS time before each run.

#### 4.2.2.5 Engine Operating Parameters

Each bus was operated at several different engine speeds to obtain a relationship between engine rpm, manifold vacuum and exhaust flow rate. An Omega model PX274 differential pressure transducer was used to monitor manifold vacuum in real time during bus operations. Near-constant exhaust tracer gas concentration was obtained by using a data logger/controller programmed with the manifold vacuum exhaust flow rate relationship and using the vacuum signal from the pressure transducer to control the tracer gas flow set point of mass flow controllers for introducing tracer gas into the bus's exhaust.

#### 4.2.2.6 Propene Measurements

Propene, the second tracer gas used in the main study, was measured using three RAE Systems ppbRAE hydrocarbon analyzers. This instrument determined the concentration of hydrocarbons using a 10.6 electron volt photoionization detector (PID) and has a lower detection limit for propene of approximately 50 ppb.

#### 4.2.2.7 Meteorological Measurements

Prevailing wind, wind direction, and temperature in the study area were determined using a system located at a height of 5 meters at CE-CERT.

A Climatronics F460 wind speed and wind direction monitoring system was connected to a Campbell 10X data logger. This system measured and processed winds into hourly averages and had an accuracy of +/-5 degrees for wind direction and +/-5% wind speed accuracy for winds greater than 5 m/s.

#### 4.2.2.8 Video Camera

A Sony DCR-TRV330 video camera was mounted in front of the bus and operated at all times when the bus was moving. The video records were stored and archived on a computer for future reference, but were not analyzed as a part of this project.



#### 4.2.2.9 Tracer Release Control

A Campbell 23X data logger was used on the follower bus to monitor engine manifold vacuum and used this signal to control the tracer gas mass flow measurements. A Campbell 21X data logger was used on the leader bus to perform the same engine manifold vacuum monitoring and tracer gas release control functions on the leader bus for runs that included the leader bus. The Campbell 23X data logger was operated at a scanning and logging rate of 10 Hz. The 21X data logger was operated at 4 Hz, its maximum scanning and logging rate.

#### 4.2.3 Data Collection

Data from the following instruments were collected using a laptop PC with Labview software and appropriate A/D cards and RS-232 multiplexers.

- AeroVironment CTA1000 continuous SF<sub>6</sub> analyzers
- EcoChem PAS 2000 particle-phase PAH analyzers
- TSI model 3022 condensation particle counters
- Garmin GPSMAP76 Global Position System
- ISSPRO R8930 magnetic sensor
- SF<sub>6</sub> mass flow sensor
- Propene mass flow sensors
- Omega PX274 differential pressure transducer

At the conclusion of each set of tests, all data were transferred to a networked PC for storage and backup. The PIDs had internal logging capabilities and were downloaded to a PC. The clocks for all of these instruments were synchronized at the beginning of each test run using the GPS time as a reference.

#### 4.2.4 Experimental Design

##### 4.2.4.1 Evaluation of Exhaust Train Leaks

Exhaust leaks were evaluated by placing a silicon stopper (with approximately 2 cm<sup>2</sup> hole) in the tailpipe of several buses. A magnehelic was also attached to the stopper to measure back pressure. Once the stopper was in place, the back pressure obtained by covering the exhaust flow, was recorded. Exhaust leaks were qualitatively evaluated by listening for hissing sounds in the exhaust system and noting any visible carbon streaks on the exterior of the bus (near the engine compartment or along the exhaust).

The back pressure method of exhaust leak detection was used on 17 school buses in the fleet from which we selected the test buses. This method is shown in Photograph 4.2.4.1.1.





**Photograph 4.2.4.1.1** Back pressure method to evaluate exhaust system leaks using a silicon stopper and magnehelic.

#### 4.2.4.2 Evaluation of Leak Potential in the Bus's Cabin

The method for determining the leak potential of bus cabins (“blower door” method) was the same method developed to measure building tightness. A centrifugal blower was set to a nominal flow rate of about 28 m<sup>3</sup> and the pressure inside the buses was measured. This method of leak testing was used to conduct a survey of 17 buses in the district’s fleet. Plastic sheeting was used on one bus, to seal off window areas to assess the contribution of those locations to overall leaks on the bus (see Photograph 4.2.4.2.1).



**Photograph 4.2.4.2.1** Sealing passenger windows with plastic sheeting to assess contribution of window leaks to overall leaks on the bus.

#### 4.2.4.3 Evaluation of Tailpipe Exhaust Intrusion (Self-Pollution)

##### 4.2.4.3.1 Tracer Gas Release System

The tracer release system was initially tested in the pilot study (Section 3.2.3) and further improved in the main study as documented in Section 5. Two tracer gases were utilized for the main study, the purpose of which was to remove variability that may have occurred between subsequent runs.

Several steps were taken to improve the performance of the release system. Pressure resulting from the intake flow and tracer gas mass flow rate were continuously monitored and recorded at 10 Hz during these tests to validate proper performance of the release system. To preclude cabin air contamination, the SF<sub>6</sub> and propene gas cylinders and associated release systems were either located outside of the passenger cabin or were checked for leaks before each test run when the bus was stopped (in these conditions the air exchange rate on the bus was low). Photograph 4.2.4.3.1.1(a, b) shows the location of the release system and associated parts outside of the bus cabin. For runs where only a single bus was used (i.e. non leader-follower runs), the tracer gas cylinders remained inside the bus.

##### 4.2.4.3.2 Self-Pollution Runs

These tests were conducted while stationary (exhaust outlet upwind) and on Route 2. Tests were conducted only if the average wind speed measured at the CE-CERT facility was less than 5 m/s. Windows were closed for all tests as opening windows would result in the air quality within the cabin being dependent primarily on roadway pollutant concentrations and impacts of exhaust from nearby vehicles (Sabin et al, 2005a, b). The degree of self-pollution in the test bus was determined with and without the following mitigation strategies: directing the bus exhaust above the height of the bus (high exhaust), use of a power ventilation system inside the bus, a combination of the two, and sealing the window areas.

To evaluate the effectiveness of high exhaust, the flow of exhaust was split with a 4” diameter “T” pipe, directing half the exhaust flow upward while the other half of the exhaust flow was directed out lower the rear of the bus. SF<sub>6</sub> was directed into one side of the split and propene into the other. The two tracers reversed positions between subsequent runs by way of the toggle switch shown in Photograph 4.2.4.3.1.1a.



(a)



(b)

**Photograph 4.2.4.3.1(a, b)** Tracer Gas Release System: (a) Toggle switch to reverse tracer gas release position and (b) Arrow points to mass flow controllers to control tracer gas release into the tailpipe.

The split exhaust arrangement is shown in Photograph 4.2.4.3.2.1, and allowed for direct simultaneous comparison of high and low exhaust position.



Original exhaust pipe location

**Photograph 4.2.4.3.2.1** Split exhaust configuration for self-pollution experiments. One tracer gas was released from each exhaust branch.

The flow rates of both tracer gases were regulated by the release system to maintain a near constant concentration in the exhaust. The exhaust volume split ratio was expected to be nearly even because each branch had the same number of bends and were the same length. This ratio was determined for every bus tested by measuring the flow rate from each exhaust branch with a pitot tube and measuring the exhaust temperature. The results are shown in Table 4.2.4.3.2.1.

**Table 4.2.4.3.2.1** Flow, as measured by pressure in inches of water for split exhaust hardware including ratios for high versus low exhaust flow for each test bus.

| Bus No. | RPM  | High Exhaust<br>(inches of H <sub>2</sub> O) | Low Exhaust<br>(inches of H <sub>2</sub> O) | Ratio |
|---------|------|--|---|-------|
| 982     | 700  | 0.15   | 0.15  | 1.0   |
|         | 2100 | 0.3  | 0.25  | 1.2   |
|         | 2650 | 0.75   | 0.75  | 1.0   |
| 872     | 2000 | 0.25   | 0.25  | 1.0   |
|         | 2850 | 0.75   | 0.65  | 1.2   |
|         | 021  | 1000   | 0.15  | 0     |
| 021     | 1500 | 0.25   | 0.23  | 1.1   |
|         | 2000 | 0.35   | 0.22  | 1.6   |
|         | 2400 | 0.7  | 0.7   | 1.0   |
| 923     | 600  | 0.18   | 0.2   | 0.9   |
|         | 1000 | 0.38   | 0.45  | 0.8   |
|         | 1500 | 0.55   | 0.55  | 1.0   |
|         | 2000 | 1.1  | 1.1   | 1.0   |
|         | 2200 | 1.7  | 1.8   | 0.9   |

Power ventilation was evaluated by placing a centrifugal blower inside the bus cabin, toward the front of the bus. Ten-inch diameter tubing was attached to the blower's inlet and the end of the tubing was positioned to bring outside air into the bus cabin. For three of the four buses tested (Buses 982, 021, and 923), the tubing was connected to a vent located at the roof of the bus. In Bus 872, the tubing was brought out through a window near the front of the bus and wrapped around to the roof of the bus. These configurations are pictured below (Photograph 4.2.4.3.2.2a-d).

Power ventilation (a centrifugal blower operating at approximately 28 m<sup>3</sup> cfm for all tests) was evaluated by alternately turning the blower on for an entire run and then off for an entire run. Both primary mitigation strategies could be tested during a single run (power ventilation, high exhaust, and combination) as exhaust tracer gas concentration was constantly monitored simultaneously at both positions and power ventilation could easily be turned on and off.

All tracer gas analyzers sampled from a single location in the bus's cabin in a typical breathing location, the middle of the bus approximately 8 cm above the seat back.





(a)



(b)



(c)



(d)

**Photograph 4.2.4.3.2.2 (a-d)** Blower inlet positions on Bus 982 (a-b) and Bus 872 (c-d).

For routine testing, a pair of SF<sub>6</sub> tracer gas analyzers and three hydrocarbon analyzers continuously measured concentrations at the reference point in the bus's cabin. An EcoChem PAS 2000 analyzer was collocated with a TSI model 3022 condensation particle counter (CPC) to monitor particle-bound PAH and concentration of particles, respectively, at the reference point. A second EcoChem PAS 2000 was used to measure roadway concentrations via a sample line extended out through a window.

For stationary tests, the bus was run at idle and positioned so the exhaust was generally upwind of the cabin. These tests were conducted during periods of calm winds (typically in the mornings) and during periods of increased on-shore winds (afternoons). As in the mobile runs, the effectiveness of high exhaust and power ventilation were evaluated. Between each run the engine was shut off and the cabin was ventilated (with the blower if necessary) to flush tracer gas from the cabin. As in the mobile runs, the two PAH and a single CPC instruments were used to collect measurements during stationary runs.

As an exploratory test, we evaluated the effect of sealing the window areas with heavy plastic sheeting for one bus. This test was conducted on-road only and not while stationary.

In summary, the following self-pollution tests were conducted on each bus: effect of exhaust position (high exhaust versus low exhaust), use of power ventilation (blower on/blower off), and a combination of the two mitigation measures (blower on and high exhaust). The route used for all self-pollution tests was Route 2 and were conducted while the test buses were stationary and mobile.

#### 4.2.4.4 Evaluation of Exhaust Intrusion from a Leader Vehicle

The purpose of these tests was to characterize the relative changes in exposure resulting from mitigation measures when following other heavy-duty diesel vehicles. In the main study, the leader vehicle was another diesel bus. The two test buses used in these experiments were Bus 982 and Bus 872. The leader bus was a Bluebird diesel bus borrowed from the UCR Transportation Services fleet.

Two types of leader/follower experiments were conducted. In both experiments all air quality instruments were located in the follower bus (the test bus). The leader bus had a second GPS for measuring position and speed, tracer gases and release system, manifold vacuum monitoring, data logging, and tracer gas injection control PC. The leader bus was equipped with release system controlled by a data logger/controller operating at its maximum update rate of 4 Hz (a 4 Hz controller was the best available to us) while the follower bus was equipped with a release system controlled by a data logger/controller operating at an update rate of 10 Hz. In the first type of leader/follower experiments, both the SF<sub>6</sub> and propene tracer gas release systems were placed in the leader bus with a split high/low exhaust “T” (Photograph 4.2.4.4.1).



**Photograph 4.2.4.4.1** Exhaust configuration for leader vehicle during leader exhaust tests to evaluate impact of following a bus with high versus low exhaust.

In the second approach, one tracer release system was placed on the leader bus and one on the follower bus, each releasing tracer gas at a low exhaust position (Photograph 4.2.4.4.2) to simulate the effects of the buses “caravanning” (as observed in our previous study), and also evaluate the impact of exhaust intrusion versus self-pollution.



(a)



(b)

**Photograph 4.2.4.4.2(a, b)** Exhaust configurations for follower bus (a) and leader bus (b) during leader exhaust/follower exhaust tests to assess impact of exhaust intrusion from a leader vehicle versus self-pollution.

The leader/follower tests were conducted in both stationary (with the leader bus upwind of the follower bus) and mobile configurations with the windows of the follower bus open and closed. The effect of power ventilation in the follower bus was also evaluated during these tests. The leader/follower tests were conducted for multiple runs on two buses in the main study.

### 4.3 Baseline Tracer Gas Measurements

The baseline for each tracer gas analyzer, or the “zero” instrument response, was determined before and after each series of up to four consecutive, half-hour runs. The average of the baseline concentrations from the beginning and end of each series of runs was then subtracted from the measured tracer gas concentrations. Between runs, the bus was ventilated by opening the windows and turning on the blower. Between some of the runs, small amounts of residual tracer gas may have been present, but this was not observed to significantly affect average run concentrations.

### 4.4 Data Analysis Methods

Because of the dynamic nature of pollution effects aboard moving vehicles, real-time data collection was emphasized in this project. Therefore, various time-series analysis techniques including descriptive analyses were employed. Descriptive analyses were also used to study overall and cyclic patterns as well as to identify outliers and turning points within the time-series. Techniques included time-series graphs, scatter plots, smoothing (e.g., moving average), as well as the estimation of statistical parameters such as arithmetic mean, standard deviation, and median. In the following section, one minute medians were used to analyze the data from the current study.



## 5.0 RESULTS AND DISCUSSION

In this study, three types of mobile testing experiments were conducted: “self-pollution” (tracer gases in test bus exhaust), “leader-follower” (tracer gases in exhaust of the leader bus, in front of the test bus) and “leader exhaust-follower exhaust” (tracers in both leader and follower bus exhaust). Results from these experiments were used to evaluate several strategies for reducing pollution in school bus cabins as discussed later in this section.

We tested four in-use school buses ranging in age from 3 to 18 years in service. A description of the buses is shown in Table 5.1.1. Buses were selected to be representative of the current school bus fleet as noted in section 4.1.1. The make and models chosen depended on the selection available from the lending District’s fleet. Bus 982 was one of the study buses tested in the previous school bus study (Bus TO1, Fitz et al, 2003). Note that the first two numbers of the bus number correspond to the last two numbers of the model year (e.g., Bus 982 is a model year 1998 and Bus 021 is a model year 2002).

**Table 5.1.1** Characteristics of the test buses.

| Bus No. | Make/Model              | Year | Mileage | Type                        |
|---------|-------------------------|------|---------|-----------------------------|
| 982     | 1998 Thomas Saf-T-Liner | 1998 | 124,000 | Diesel (with particle trap) |
| 872     | 1987 Blue Bird          | 1987 | 324,000 | Diesel                      |
| 021     | 2002 Thomas Saf-T-Liner | 2002 | 66,000  | Diesel                      |
| 923     | 1993 Carpenter SPT-3908 | 1992 | 128,000 | Diesel (converted from CNG) |

Table 5.1.2 describes all mobile runs conducted in the study, including test date (mmdd), bus number, type of test conducted, route number on which the testing was conducted, window position, tracer gas release positions, and power ventilation (blower operation). During mobile testing, our test buses traveled over one of two selected routes (discussed earlier) and all such runs were conducted in the late morning to the late afternoon.

Table 5.1.3 shows meteorological data including wind speed, wind direction, temperature, relative humidity, and respective standard deviations for most study days. The data in this table summarize conditions during which mobile tests were conducted. Meteorological conditions were stable across these test periods. Mean wind speed and direction over all mobile runs were 3 m/s and 256 degrees, respectively. Temperature and relative humidity for all mobile runs averaged 24 °C and 38%, respectively.

**Table 5.1.2** Description of all mobile runs (conducted in 2005)

| Test Date | Run Number | Bus Number | Run Type                        | Route No. | Window Position | SF <sub>6</sub> Release Position | Propene Release Position | Blower |
|-----------|------------|------------|---------------------------------|-----------|-----------------|----------------------------------|--------------------------|--------|
| 0405      | 13         | 982        | Self-Pollution                  | 2         | Closed          | High                             | Low                      | Off    |
| 0405      | 14         | 982        | Self-Pollution                  | 2         | Closed          | Low                              | High                     | Off    |
| 0405      | 15         | 982        | Self-Pollution                  | 2         | Closed          | Low                              | High                     | On     |
| 0405      | 16         | 982        | Self-Pollution                  | 2         | Closed          | High                             | Low                      | On     |
| 0406      | 17         | 982        | Self-Pollution                  | 2         | Closed          | High                             | Low                      | Off    |
| 0406      | 18         | 982        | Self-Pollution                  | 2         | Closed          | Low                              | High                     | Off    |
| 0406      | 19         | 982        | Self-Pollution                  | 2         | Closed          | Low                              | High                     | On     |
| 0406      | 20         | 982        | Self-Pollution                  | 2         | Closed          | High                             | Low                      | On     |
| 0407      | 21         | 982        | Self-Pollution                  | 2         | Closed          | High                             | Low                      | Off    |
| 0407      | 22         | 982        | Self-Pollution                  | 2         | Closed          | Low                              | High                     | Off    |
| 0412      | 23         | 982        | Leader Exhaust                  | 1         | Open            | High                             | Low                      | Off    |
| 0412      | 24         | 982        | Leader Exhaust                  | 1         | Open            | Low                              | High                     | Off    |
| 0412      | 25         | 982        | Leader Exhaust                  | 1         | Closed          | High                             | Low                      | On     |
| 0412      | 26         | 982        | Leader Exhaust                  | 1         | Closed          | Low                              | High                     | On     |
| 0412      | 27         | 982        | Leader Exhaust                  | 1         | Closed          | High                             | Low                      | Off    |
| 0412      | 28         | 982        | Leader Exhaust                  | 1         | Closed          | Low                              | High                     | Off    |
| 0413      | 29         | 982        | Leader Exhaust Follower Exhaust | 1         | Open            | Low                              | Low                      | Off    |
| 0413      | 30         | 982        | Leader Exhaust Follower Exhaust | 1         | Closed          | Low                              | Low                      | On     |
| 0413      | 31         | 982        | Leader Exhaust Follower Exhaust | 1         | Closed          | Low                              | Low                      | Off    |
| 0419      | 32         | 872        | Leader Exhaust                  | 1         | Open            | High                             | Low                      | Off    |
| 0419      | 33         | 872        | Leader Exhaust                  | 1         | Open            | Low                              | High                     | Off    |
| 0419      | 34         | 872        | Leader Exhaust                  | 1         | Closed          | High                             | Low                      | Off    |
| 0419      | 35         | 872        | Leader Exhaust                  | 1         | Closed          | Low                              | High                     | Off    |
| 0419      | 36         | 872        | Leader Exhaust                  | 1         | Closed          | High                             | Low                      | On     |
| 0419      | 37         | 872        | Leader Exhaust                  | 1         | Closed          | Low                              | High                     | On     |
| 0420      | 38         | 872        | Leader Exhaust Follower Exhaust | 1         | Open            | Low                              | Low                      | Off    |
| 0420      | 39         | 872        | Leader Exhaust Follower Exhaust | 1         | Closed          | Low                              | Low                      | On     |
| 0420      | 40         | 872        | Leader Exhaust Follower Exhaust | 1         | Closed          | Low                              | Low                      | Off    |
| 0420      | 41         | 872        | Leader Exhaust Follower Exhaust | 1         | Open            | Low                              | Low                      | Off    |
| 0420      | 42         | 872        | Leader Exhaust Follower Exhaust | 1         | Closed          | Low                              | Low                      | On     |
| 0420      | 43         | 872        | Leader Exhaust Follower Exhaust | 1         | Closed          | Low                              | Low                      | Off    |
| 0427      | 44         | 872        | Self-Pollution                  | 2         | Closed          | High                             | Low                      | Off    |
| 0427      | 45         | 872        | Self-Pollution                  | 2         | Closed          | Low                              | High                     | Off    |
| 0427      | 46         | 872        | Self-Pollution                  | 2         | Closed          | Low                              | High                     | On     |
| 0427      | 47         | 872        | Self-Pollution                  | 2         | Closed          | High                             | Low                      | On     |
| 0503      | 52         | 021        | Self-Pollution                  | 2         | Closed          | Low                              | High                     | Off    |
| 0503      | 53         | 021        | Self-Pollution                  | 2         | Closed          | High                             | Low                      | Off    |
| 0503      | 54         | 021        | Self-Pollution                  | 2         | Closed          | High                             | Low                      | On     |
| 0503      | 55         | 021        | Self-Pollution                  | 2         | Closed          | Low                              | High                     | On     |
| 0504      | 56         | 021        | Self-Pollution                  | 2         | Closed          | Low                              | High                     | Off    |
| 0504      | 57         | 021        | Self-Pollution                  | 2         | Closed          | High                             | Low                      | Off    |
| 0504      | 58         | 021        | Self-Pollution                  | 2         | Closed          | High                             | Low                      | On     |
| 0504      | 59         | 021        | Self-Pollution                  | 2         | Closed          | Low                              | High                     | On     |
| 0510      | 60         | 923        | Self-Pollution                  | 2         | Closed          | Low                              | High                     | Off    |
| 0510      | 61         | 923        | Self-Pollution                  | 2         | Closed          | High                             | Low                      | Off    |
| 0510      | 62         | 923        | Self-Pollution                  | 2         | Closed          | High                             | Low                      | On     |
| 0510      | 63         | 923        | Self-Pollution                  | 2         | Closed          | Low                              | High                     | On     |
| 0511      | 64         | 923        | Self-Pollution                  | 2         | Closed          | Low                              | High                     | Off    |
| 0511      | 65         | 923        | Self-Pollution                  | 2         | Closed          | High                             | Low                      | Off    |
| 0511      | 66         | 923        | Self-Pollution                  | 2         | Closed          | High                             | Low                      | On     |

**Table 5.1.3** Meteorological data during mobile runs (with standard deviations)

| <b>Test Date (2005)</b> | <b>Average Wind Speed (m/s)</b> | <b>Average Wind Direction (deg)</b> | <b>Temperature (°C)</b> | <b>Relative Humidity (%)</b> |
|-------------------------|---------------------------------|-------------------------------------|-------------------------|------------------------------|
| 0406                    | NA                              | NA                                  | NA                      | NA                           |
| 0407                    | 4 ±0.4                          | 256 ±5                              | 22 ±0.7                 | 38 ±4.2                      |
| 0412                    | 2.8 ±0.3                        | 245 ±11                             | 28 ±1.2                 | 24 ±0.5                      |
| 0413                    | 3 ±0.3                          | 259 ±11                             | 26 ±0.6                 | 34 ±2.6                      |
| 0419                    | 3.8 ±0.4                        | 262 ±6                              | 19 ±1.0                 | 46 ±4.0                      |
| 0420                    | 2.6 ±0.4                        | 259 ±14                             | 23 ±0.6                 | 32 ±5.6                      |
| 0427                    | 3.5 ±0.4                        | 258 ±7                              | 19 ±0.7                 | 49 ±1.2                      |
| 0503                    | 2.6 ±0.6                        | 265 ±11                             | 26 ±0.5                 | 45 ±2.3                      |
| 0504                    | 2.7 ±0.2                        | 252 ±8                              | 26 ±0.8                 | 50 ±2.5                      |
| 0510                    | 3.5 ±0.4                        | 249 ±16                             | 22 ±0.7                 | 32 ±2.4                      |
| 0511                    | 3 ±0.4                          | 255 ±9                              | 26 ±0.4                 | 28 ±1.3                      |

### 5.1 Tracer Gas Release System

Upon receipt of each bus we did stationary measurements to determine the range and relationship between engine RPM and both exhaust flow rate and manifold vacuum. Based on the exhaust flow rate range for each bus, we established a tracer gas flow rate in relation to the exhaust flow rate. Because the bus engine parameters varied significantly from one another, the tracer gas flow rate relationship was established independently for each bus to keep the tracer gas at measurable levels and also to be within the range of our controllers. Therefore the average tracer flow rates varied from bus to bus because the nominal flow rates were changed to accommodate the exhaust flow rate range of each bus and the dynamic operating range of the tracer gas flow controllers and detection range of the tracer analyzers.

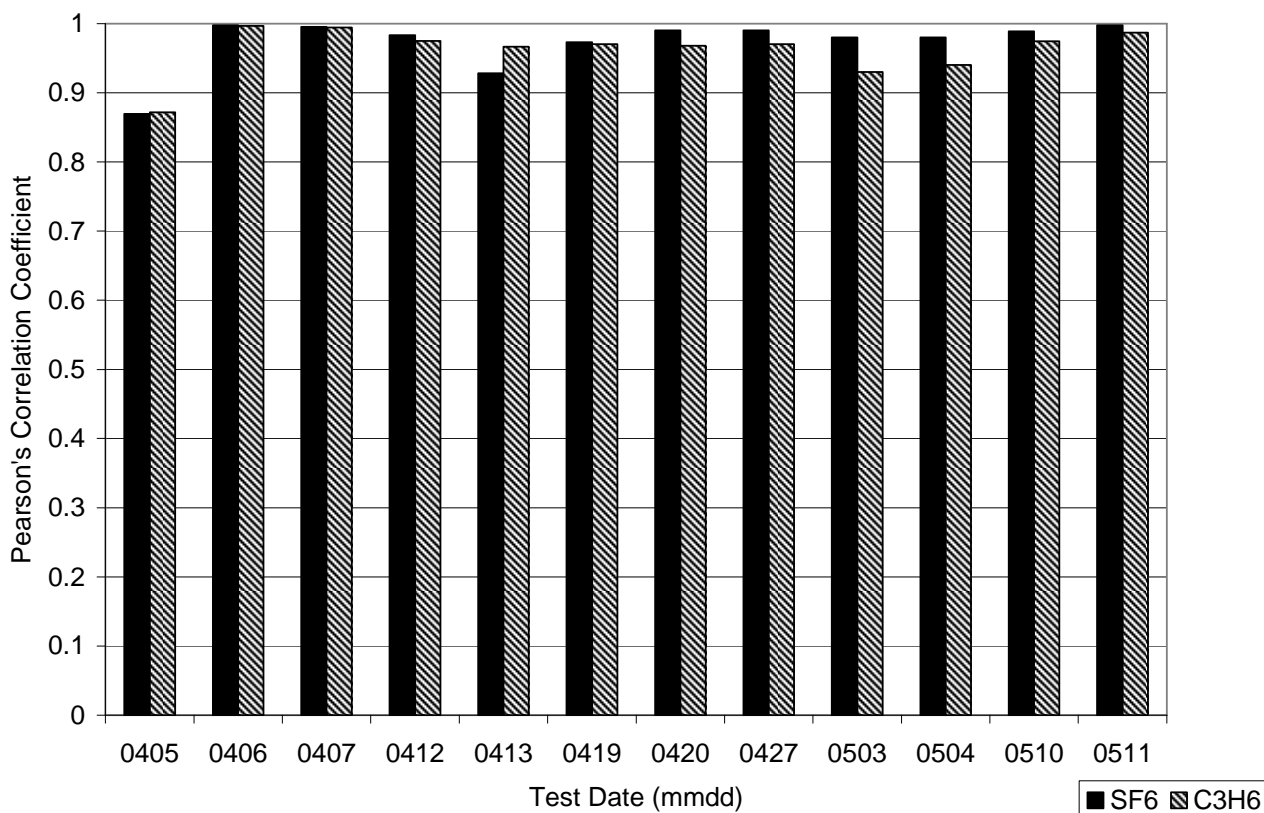
#### 5.1.1 Validation

Validation of the tracer gas release system described in Section 3.2.3 was an important component of this study. As discussed earlier, the purpose of the release system was to control the amount of tracer gas released into the tailpipe to maintain a constant concentration of tracer gas in the exhaust. Based on our experience in the pilot study, efforts were made to improve the performance of the release system in the main study. The following two methods were used to validate the method of maintaining constant concentration of tracer gas in the bus exhaust.

### 5.1.1.1 Pearson's Correlation Coefficient

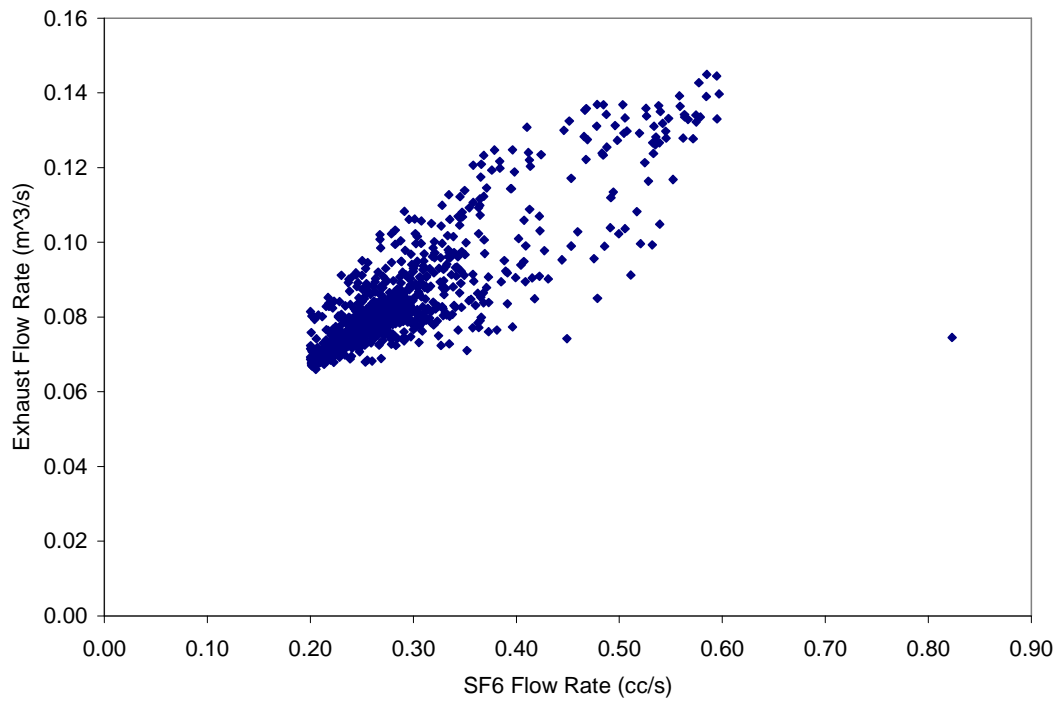
Pearson's correlation coefficient between the measured bus exhaust flow and the amount of tracer gas flow released into the tailpipe was calculated. Perfect correlation between these two variables would indicate the release system was functioning and would correspond to a Pearson's correlation coefficient ( $r$ ) of +1.0. The resulting correlation coefficients are shown in Figure 5.1.1.1.1 for each test day (the aggregate of data for up to six individual runs per day).

When we examined the Pearson's correlation coefficients for both SF<sub>6</sub> and propene tracer gases for all days (mobile runs), it appeared the release systems for the two tracer gases performed well for all mobile runs conducted during the study with an overall average correlation coefficient for both release systems of  $0.97 \pm 0.04$ . For the SF<sub>6</sub> and propene tracer gas release systems, all runs had coefficients greater than 0.80. The average value of 0.97 is similar to the value obtained in the pilot study,  $r=0.93$ , which was determined from two runs testing the release system. However, for a majority of the runs in the main study, the release system performed at least as well, or better than in the pilot study.

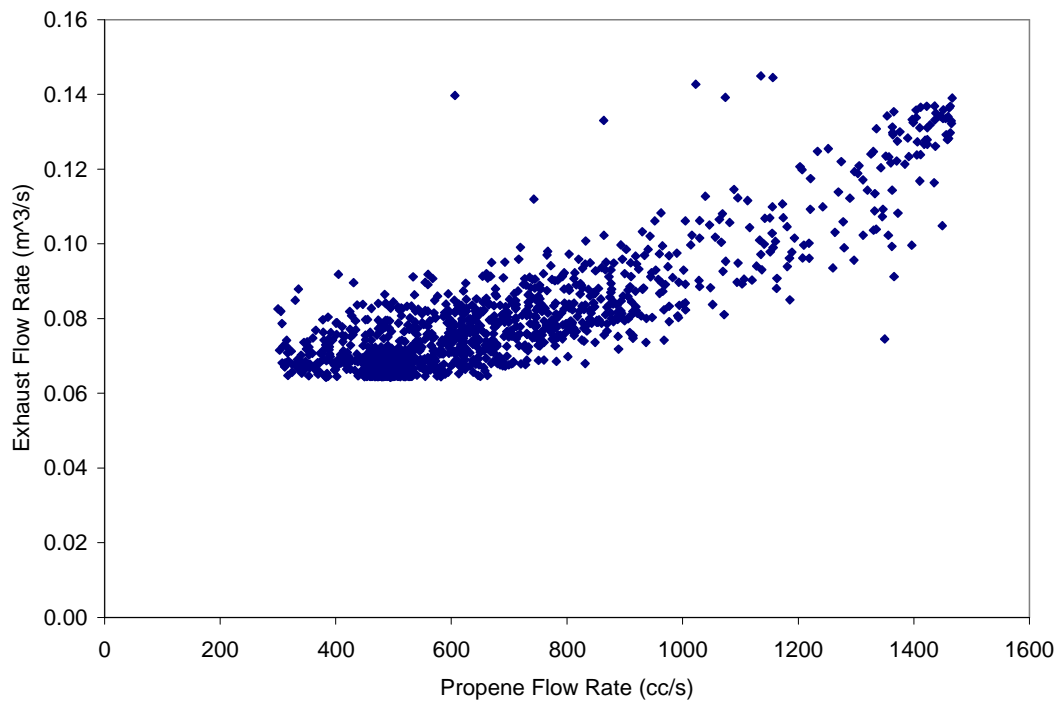


**Figure 5.1.1.1.1** Pearson's correlation coefficient for each day of mobile testing in the main study.

Both SF<sub>6</sub> and propene tracer gases were released from the test bus during self-pollution runs. The average Pearson's correlation coefficient for the release system for self pollution runs was  $0.94 \pm 0.06$  for both tracer gases. Figure 5.1.1.1.2 and 5.1.1.1.3 shows scatter plots of exhaust flow versus tracer gas flow on a typical run, Run 44 on 4/27, for the SF<sub>6</sub> and propene tracer gas release system. Further discussion on calculation of tracer gas concentration in the exhaust is discussed in Section 5.1.1.2.



**Figure 5.1.1.1.2** Scatter plots of exhaust flow versus SF<sub>6</sub> flow rate for 0427/Run 44.



**Figure 5.1.1.1.3** Scatter plots of exhaust flow versus propene flow rate for 0427/Run 44.

### 5.1.1.2 Tracer Gas Concentration in Exhaust

A second method for evaluating the performance of the release system was to investigate the concentration of tracer gas in the exhaust. Since conducting direct measurements in the exhaust was not feasible in this study (the high concentrations required were far beyond the range of the high sensitivity analyzers required after dilution), tracer gas concentration in the exhaust was calculated using Equation 5.1 below, as described in detail in Fitz et al. (2003) and Behrentz et al. (2004).

$$C_{exh} = C_{cyl} * \frac{Q_{cyl}}{Q_{exh} + Q_{cyl}} \quad (5.1)$$

where:

$Q_{exh}$  = Exhaust flow  $\approx$  Exhaust intake flow

$C_{exh}$  = Concentration of tracer gas in the exhaust

$Q_{cyl}$  = Tracer gas flow from the compressed gas cylinder

$C_{cyl}$  = Concentration of tracer gas in the compressed gas cylinder

Table 5.1.1.2.1 shows the average concentration and standard deviation of SF<sub>6</sub> and propene in the exhaust including test type, test day, and bus number.

**Table 5.1.1.2.1** Variation of SF<sub>6</sub> and propene exhaust concentrations for all mobile runs in the main study.

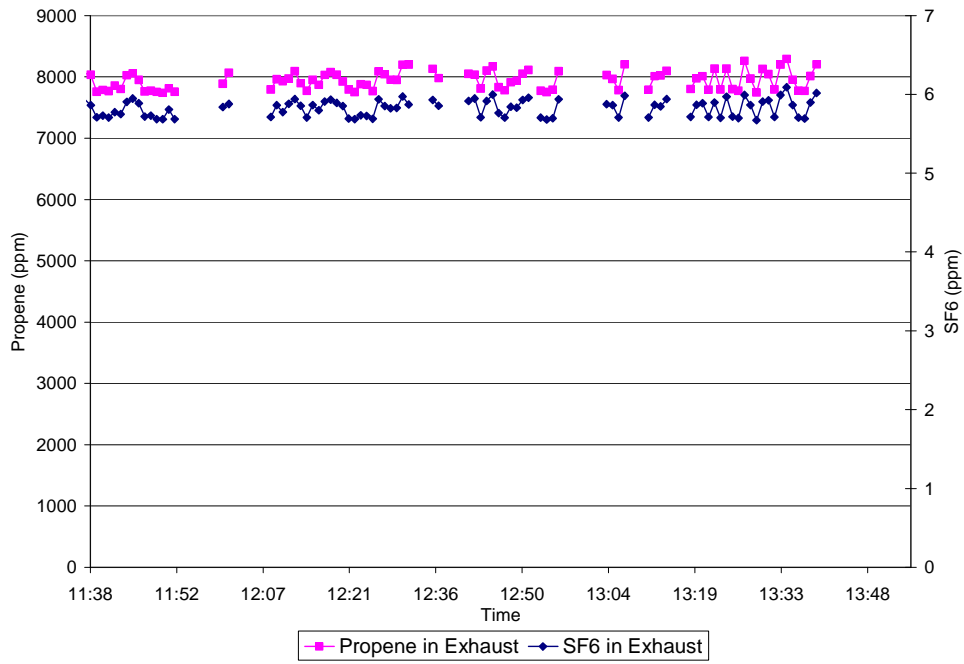
| Test Type | Test Date<br>-2005 | Bus<br>No. | SF <sub>6</sub> (ppm) |                       | C <sub>3</sub> H <sub>6</sub> (ppm) |                       |
|-----------|--------------------|------------|-----------------------|-----------------------|-------------------------------------|-----------------------|
|           |                    |            | Average               | Standard<br>Deviation | Average                             | Standard<br>Deviation |
| SP        | 0405               | 982        | 5.8                   | 0.1                   | 7900                                | 150                   |
| SP        | 0406               | 982        | 5.8                   | 0.1                   | 7900                                | 160                   |
| SP        | 0407               | 982        | 6.3                   | 0.1                   | 8000                                | 150                   |
| LE        | 0412               | 982        | 4.6                   | 0.4                   | 7700                                | 710                   |
| LE-FE     | 0413               | 982        | 3.0                   | 0.1                   | 3900                                | 330                   |
| LE        | 0419               | 872        | 4.6                   | 0.4                   | 7700                                | 720                   |
| LE-FE     | 0420               | 872        | 2.0                   | 0.1                   | 3900                                | 360                   |
| SP        | 0427               | 872        | 3.3                   | 0.4                   | 8000                                | 1100                  |
| SP        | 0503               | 21         | 4.3                   | 1.0                   | 5300                                | 280                   |
| SP        | 0504               | 21         | 5.8                   | 0.2                   | 5300                                | 260                   |
| SP        | 0510               | 923        | 3.9                   | 0.2                   | 7900                                | 350                   |
| SP        | 0511               | 923        | 3.8                   | 0.3                   | 8300                                | 420                   |

For self-pollution tests the average percent standard deviation for SF<sub>6</sub> and propene concentrations in the exhaust was 7% and 5% respectively. For leader exhaust runs (0412, 0419) the average percent standard deviation for SF<sub>6</sub> and propene exhaust concentrations were both 9%. For leader exhaust-follower exhaust runs (0413, 0420) the average percent standard deviation for SF<sub>6</sub> and propene exhaust concentrations were 6% and 11% respectively. The higher average variations were most likely due to the 4 Hz release system as discussed below.

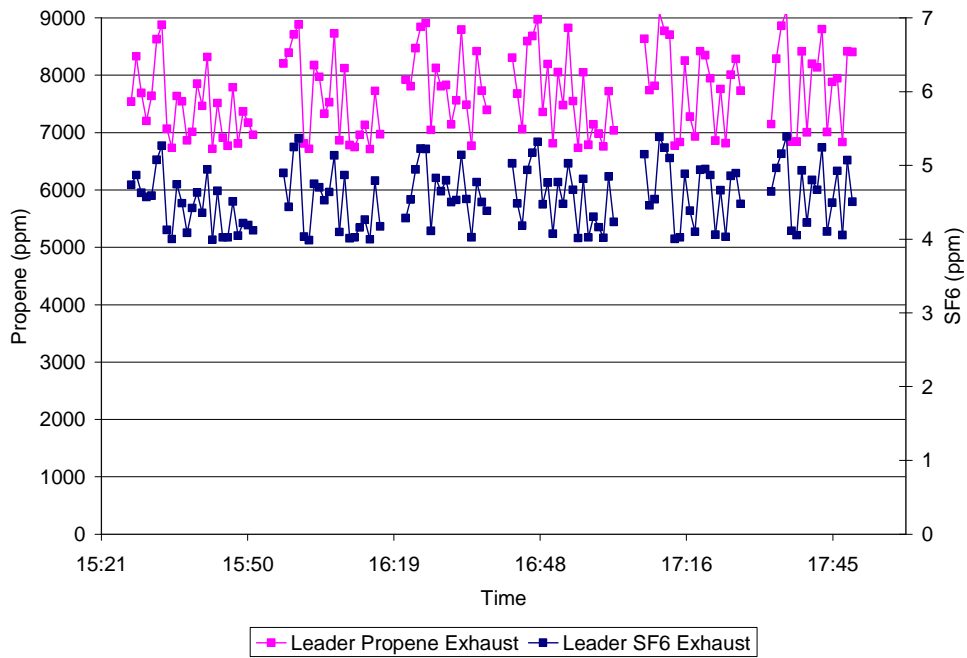
The recording speed of the release system (10 Hz versus 4 Hz) affected the variability of tracer gas concentration in the exhaust. The SF<sub>6</sub> release system operated at 10 Hz and was always used on the follower bus, and for all buses tested for self-pollution except during the leader exhaust experiments. The propene release system operated at 10 Hz for all buses tested for self-pollution and was always on the leader bus during leader-follower tests; for these runs, both the propene and SF<sub>6</sub> release system operated at 4 Hz. Use of a 4 Hz release system decreased the sensitivity of the tracer gas release system, but operated well as shown by correlation coefficients for the relationship between exhaust flow and tracer gas flow for propene of 0.97 (for all leader-follower experiments) and 0.96 for SF<sub>6</sub> (for leader exhaust-follower exhaust experiments only).

In Figure 5.1.1.2.1a, one minute medians of SF<sub>6</sub> and propene exhaust concentrations ( $C_{\text{exh}}$ ) are plotted against time for a typical day in the main study (0405). On 0405, both release systems operated at 10 Hz using the Campbell 23X controller in the test bus. This time series is contrasted with a time series from leader-exhaust runs on 0412 (Figure 5.1.1.2.1b) when both SF<sub>6</sub> and propene release systems were controlled by the Campbell 21X controller operating at its maximum rate (4 Hz) on the leader bus. Larger variability in exhaust concentrations for both tracer gases was seen for the 4 Hz system on 0412. A second 10Hz controller was not available for this study and the 4Hz controller was the best controller available to us as mentioned previously.

In summary, for the main study, we were able to assess the performance of the tracer gas release systems and show the system maintained a relatively constant concentration of tracer gas in the exhaust within 10% of mean tracer gas concentrations (for one standard deviation).



(a)



(b)

**Figure 5.1.1.2.1 (a, b)** Time series of one-minute medians of SF<sub>6</sub> (10 Hz release system) and propene (4 Hz release system) exhaust concentrations for 0405(a) and 0412(b).



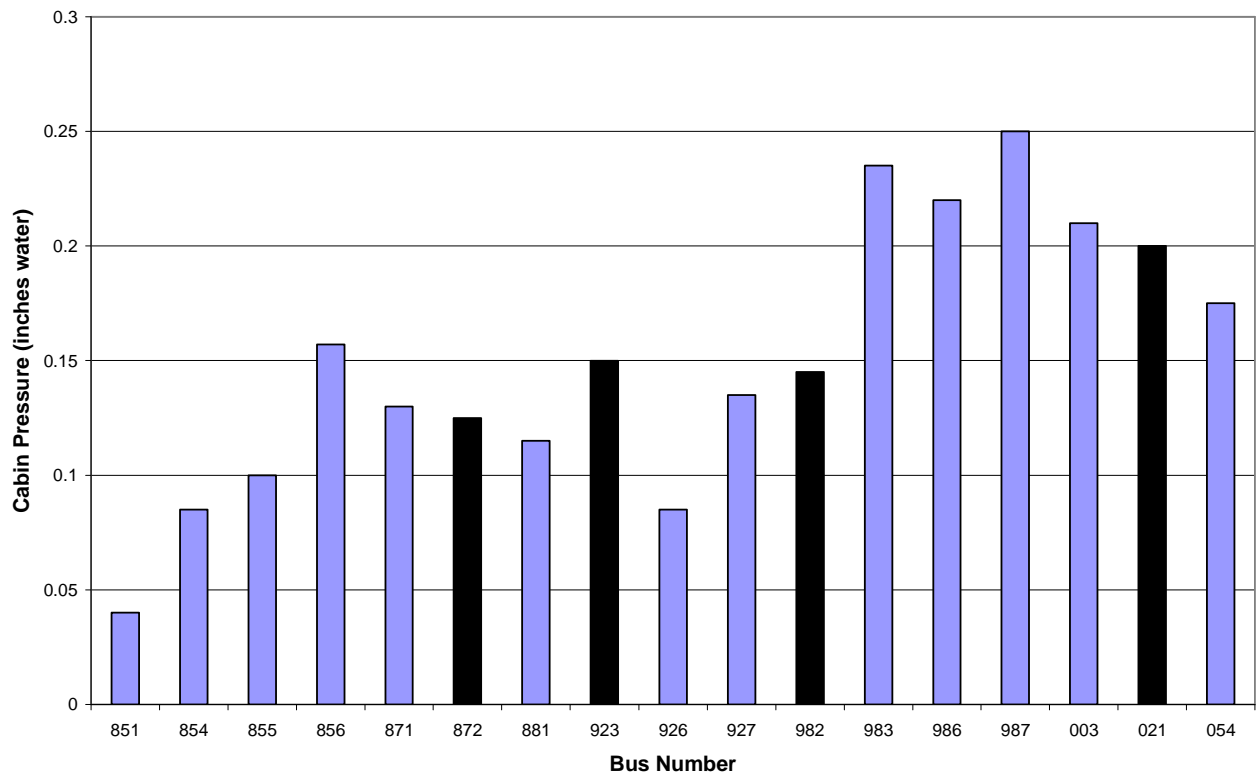
## 5.2 Bus Cabin Leak Potential

### 5.2.1 Evaluation of Overall Bus Cabin Leak Potential

Cabin leak potential may be defined as the extent of cracks, holes, gaps, or other openings in a bus cabin. These openings are potential pathways for self-pollution and/or exhaust intrusion from other vehicles, as well as intrusion of ambient air (roadway air). The following sections discuss methods to evaluate the extent of openings or leak potential in bus cabin.

#### 5.2.1.1 Rapid Evaluation of Overall Cabin Leak Rate

A rapid method for determining a measure of overall cabin leak rate, the “blower door” method discussed in Section 4.2.4.2, was evaluated for a total of 17 buses. All buses were diesel except bus 054, a model year 2005 CNG bus. The “blower door” method was based on measurement of the cabin pressure produced by an approximately constant, high volume blower rate. As seen in Figure 5.2.2.1.1, these data show a wide range of variability in cabin pressure, which is inversely related to cabin leak potential, for buses of varying ages and types.



**Figure 5.2.1.1.1** Survey of bus cabin pressures using the “blower door” method. Note the first two digits of the bus number correspond to the model year. Black bars represent buses used in the main study.

Cabin pressures for these buses ranged from 0.04 to 0.25 inches of water. There appeared to be a trend of newer buses being “tighter” than older buses, with buses built in the late 1990’s and early 2000’s exhibiting the highest pressures (or lowest leak rate). Several buses exhibited higher than expected cabin pressures, based on their ages, including bus 856 and bus 923 (the latter was one of the four buses used in the main study). Replicate measurements of cabin pressure for buses 856, 872, and 927 were taken on separate days with differences between the two measurements ranging from 4 to 10%.

On many buses, the front door carried the greatest potential for leaks as seals were weak and/or large gaps were visible around the door area, especially at the bottom of the door in a number of cases (see Photograph 3.2.2.1). When we covered the doors, the cabin pressure increased by about 0.02 inches of water across most buses we tested. From these experiments, we drew two principal conclusions. First, the observation in our earlier school bus study that older school buses in general were less well constructed and/or through age and wear had developed observable openings in the cabin and around doors and windows, was generally confirmed by the pressure measurements we made in the present study; a trend of decreasing leak rates was observed from 1985 to 2005 buses. Second, we believe the “blower door” method developed to measure the pressure (or leak rate) in school buses could be employed by school bus maintenance staff to identify the relative leak rate of buses. This information could be used, in part, to follow one of our previous recommendations to place the “cleanest” buses within a school district on the longest routes. However, it should be noted that self-pollution also depends on other additional factors such as emission rate.

### 5.2.2 Quantification

Self-pollution, as described in Behrentz et al. (2004), is the percentage of air in the bus cabin that can be attributed to the bus’s own exhaust, or, in this study, the ratio between the concentration of tracer gas in the bus cabin and the concentration of tracer gas in the exhaust. To calculate self-pollution, first, the concentration of tracer gas in the exhaust ( $C_{exh}$ ) is determined from Equation 5.1 as discussed earlier:

$$C_{exh} = C_{cyl} * \frac{Q_{cyl}}{Q_{exh} + Q_{cyl}} \quad (5.1)$$

Second, using direct measurements of SF<sub>6</sub> inside the cabin we define percent self-pollution as:

$$Self-Pollution = \frac{C_{cabin}}{C_{exh}} * 100 \quad (5.2)$$

Using Equations 5.1 and 5.2, we were able to determine the degree of self-pollution across all test buses. This metric was also used to (a) assess the potential for exhaust intrusion due to leaks in the bus cabin, and (b) investigate the effectiveness of proposed mitigation measures as discussed in detail below.

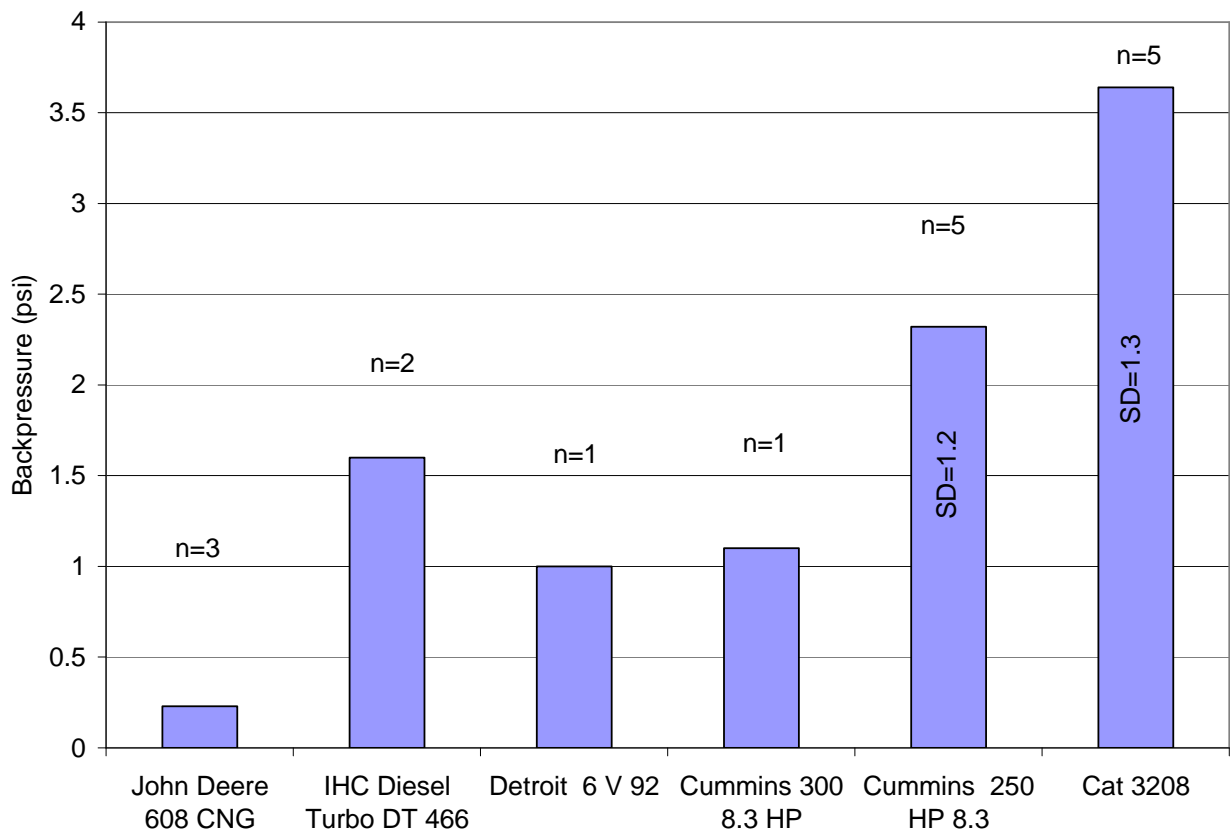
### 5.3 Exhaust Leaks

A systematic method for detecting exhaust train leaks was developed in the pilot study, but this method was time consuming and was not recommended for use in the main study. Instead, simple and rapid measures for exhaust system leak detection were developed. These involved both qualitative measures (e.g. noise of escaping gas in the exhaust system when a cork was placed in the tailpipe, or the presence of visible carbon streaks on the outside of the bus near the engine compartment) and semi-quantitative measures described below.

In general, the qualitative assessments we employed to identify exhaust system leaks failed to

reveal any substantial evidence of leaks in the exhaust trains of the 17 buses tested. This was consistent with results from our earlier study (Fitz et al., 2003) and our hypothesis that exhaust system leaks were unlikely to be a prevalent contribution to self-pollution, especially relative to the impacts of school bus tailpipe emissions.

The same 17 buses (as in the cabin pressure measurements described in the previous section and mentioned previously) were tested for semi-quantitative characterization of exhaust leaks using the method described in Section 4.2.4.1. At the beginning of this study we thought backpressure measurements might be a good indicator of exhaust leaks; a bus with low exhaust backpressure might indicate a leaky exhaust train. Backpressures measured using our exhaust restrictor apparatus ranged from 0.2-4.0 psi, a range that could not be explained by exhaust system leaks alone. Out of the 17 buses surveyed, three buses exhibited evidence for possible exhaust leaks. As seen in Figure 5.3.1 the measured backpressures varied by engine type/manufacturer (1-5 buses were tested per engine type), with the John Deere CNG-powered buses exhibiting the lowest backpressure while the Caterpillar diesel-powered buses showed the highest. We conclude backpressure measurements were dominated by engine type, but it may be possible to use these backpressure measurements by considering the value expected for each engine type.



**Figure 5.3.1** Backpressure measurements in psi for the six engine types tested in the exhaust leak experiment (n is the number of buses tested for each engine type). Standard deviations are provided for the Cummins 250 and Cat 3208 engines.

## 5.4 Mitigation Measures

As discussed earlier, three major mitigation strategies for reducing self-pollution inside bus cabins were tested: (1) high versus low exhaust position on both the test bus and a leader bus; (2) the use of a blower to pressurize the inside of the test bus cabin (i.e. power ventilation); and (3) sealing the windows. The first two mitigation measures were tested individually and in combination. The next several sections discuss the results obtained from testing these three mitigation strategies.

In these analyses, our most quantitative comparisons are based on data obtained from the last five days (starting 0427). Earlier runs encountered problems that prevented fully quantitative comparison. One problem involved residual tracer gas concentrations in the cabin: the cabin was not adequately flushed of tracer gas between runs up through 0407. The tests before that date can be compared qualitatively, but overall self-pollution averages cannot be calculated. A second problem was the blower exhaust port being inadvertently left uncovered until the last five days of the study. While this may not have significantly affected results, with the blower exhaust port uncovered and the blower turned off, the bus may have been able to allow outside air to enter the cabin and/or create a “negative” pressure in the bus while it was moving. Therefore, we cannot rule out the potential for bus exhaust to have entered the bus and to have potentially created the appearance of higher self-pollution than would have been the case had the blower port been covered. The results obtained prior to covering the blower still allow direct qualitative comparison of mitigation method effectiveness, depending on the run type, but not quantitative comparison.

### 5.4.1 Effect of High Exhaust Position When Driven on the Test Route

Since self-pollution is a phenomenon that primarily occurs when windows are closed (Behrentz et al., 2004; Sabin et al., 2005a), all self-pollution runs used to test the effects of high versus low exhaust positions were conducted with windows closed.

In these experiments, SF<sub>6</sub> and propene were released simultaneously from a split tailpipe with one tracer released from the high exhaust position and one tracer released from the low exhaust position for the duration of one bus loop around Route 2 described in Section 4.1.3.2. The two tracer gas positions were then switched for the next loop around the test route with up to four consecutive runs per day conducted in this manner.

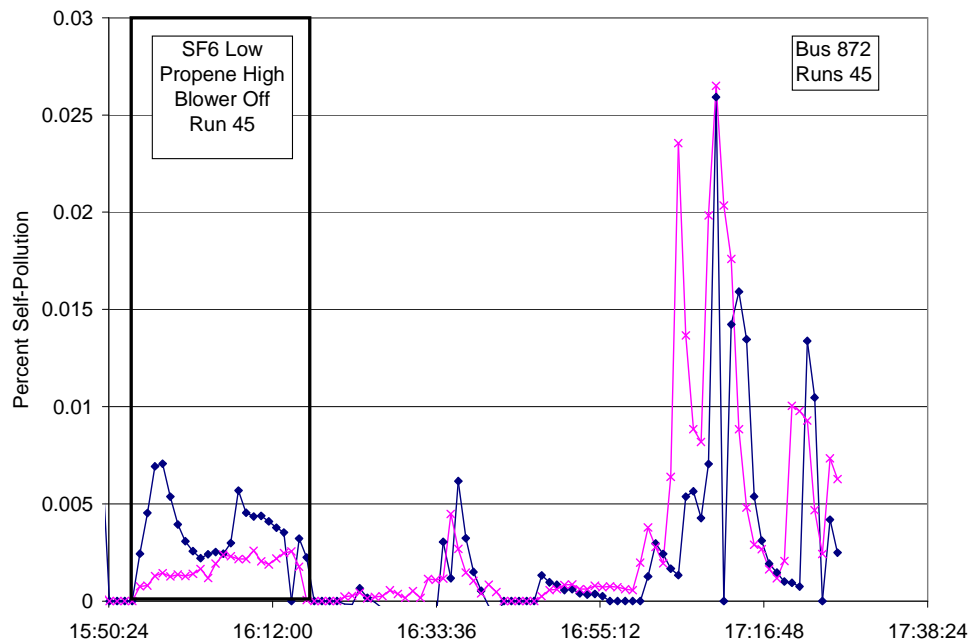
#### 5.4.1.1 Effect of High Exhaust Position on Self-Pollution When Bus in Motion

Figures 5.4.1.1a-d presents examples of several time series of in-cabin concentrations of tracer gas during the final five days of testing excluding the first run of 0427 as the blower exhaust port was not covered for that run. The data include seven runs over 3 buses (Bus 872, 021 and 923) and one test route (Route 2). To eliminate confounders such as differences in meteorology and other experimental conditions between runs, we compared the effect of high versus low exhaust (SF<sub>6</sub> high and propene low or SF<sub>6</sub> low and propene high) within a single run, taking advantage of our use of a split tailpipe with dual tracer release.

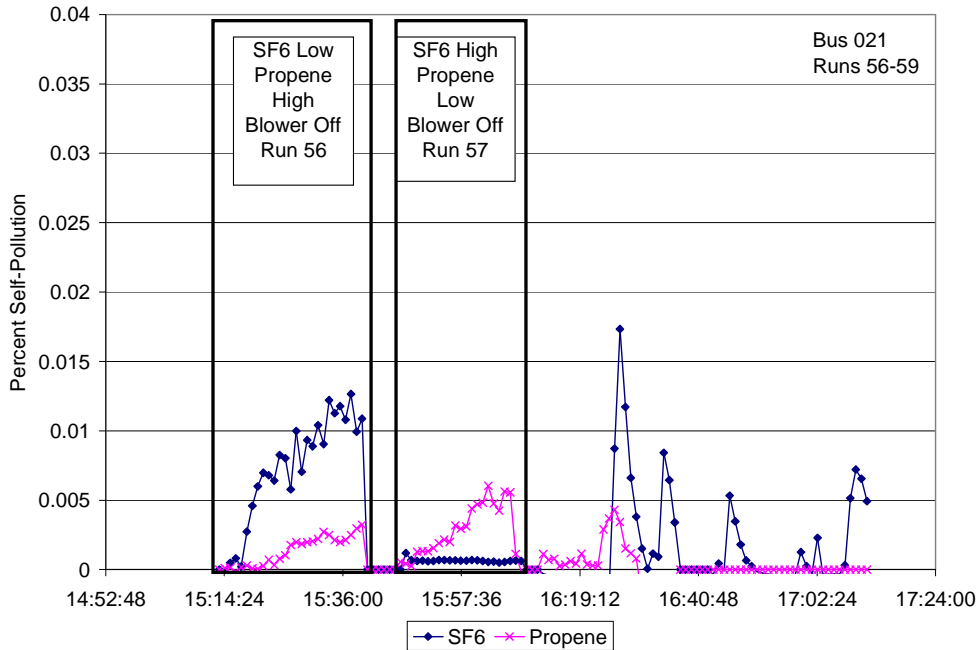
Examining the first run on 0504, 0510, 0511 (Figures 5.4.1.1b-d), and the second run on 0504, 0510, and 0511, and Run 45 (0427) (Figures 5.4.1.1a-d), we found within each run, the high exhaust position consistently resulted in lower self-pollution compared to the low exhaust position. This observation is summarized by data in Table 5.4.1.1.1, which shows the percent self-pollution for individual runs. For all runs but one, the high exhaust position resulted in 35-95% decrease in self-pollution compared to the low exhaust position. In Run 61, a 112% increase in self-pollution was observed. Overall, however, the high exhaust position appears to be a promising approach to

reducing self-pollution in school buses. (Note: During Run 52 and 53, butanol was detected in the bus, originating from a broken lead on the CPC instrument. Butanol, having an ionization energy of 9.99 eV, was detected by our PIDs which employ a 10.6 eV lamp. Increased concentrations of butanol in the cabin led to higher PID readings creating the appearance of propene tracer intrusion. As a result, these runs were discarded from our propene analyses).

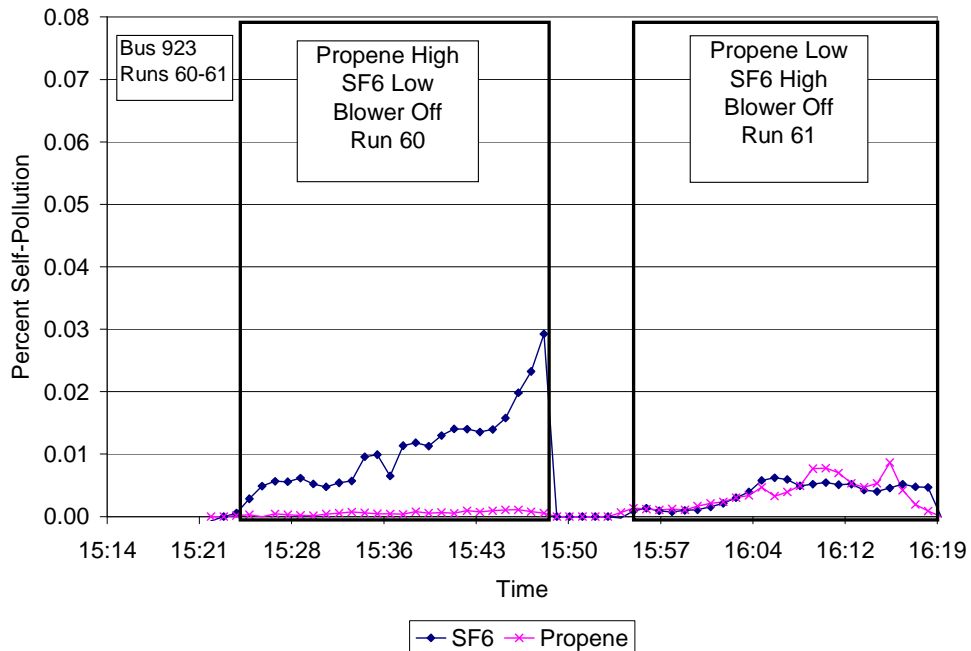
Propene data from Runs 62 and 63 from 0510 were also excluded from our analyses due to diminishing supply of propene gas during these two runs.



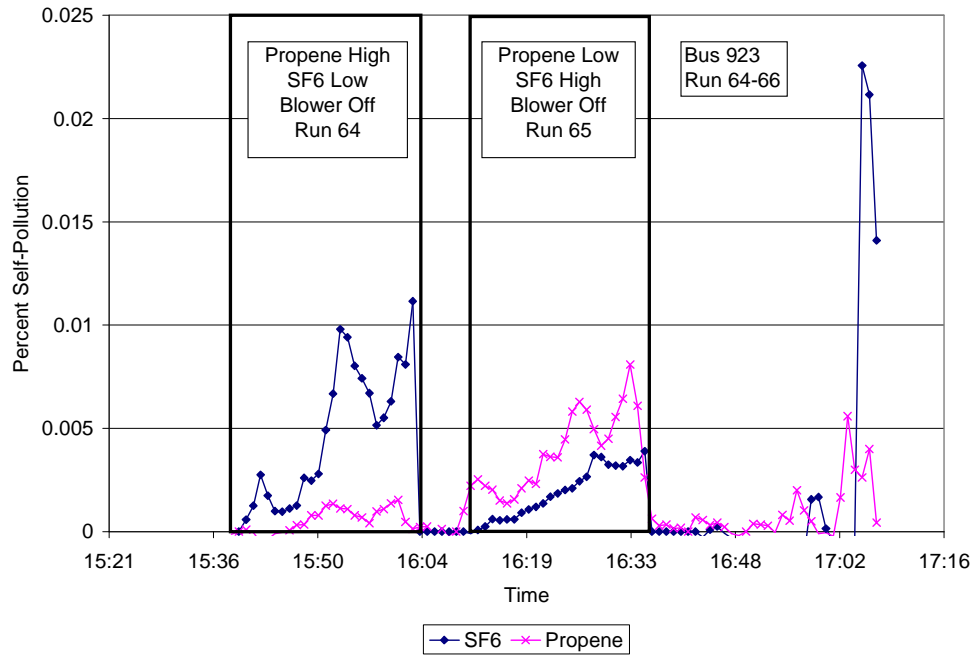
**Figure 5.4.1.1.1 (a)** Time series of percent self-pollution for SF<sub>6</sub> and propene during mobile runs conducted on 0427.



**Figure 5.4.1.1.1 (b)** Time series of percent self-pollution for SF<sub>6</sub> and propene during mobile runs conducted on 0504.



**Figure 5.4.1.1.1 (c)** Time series of percent self-pollution for SF<sub>6</sub> and propene during mobile runs conducted on 0510.



(d)

**Figure 5.4.1.1.1 (d)** Time series of percent self-pollution for SF<sub>6</sub> and propene during mobile runs conducted on 0511.

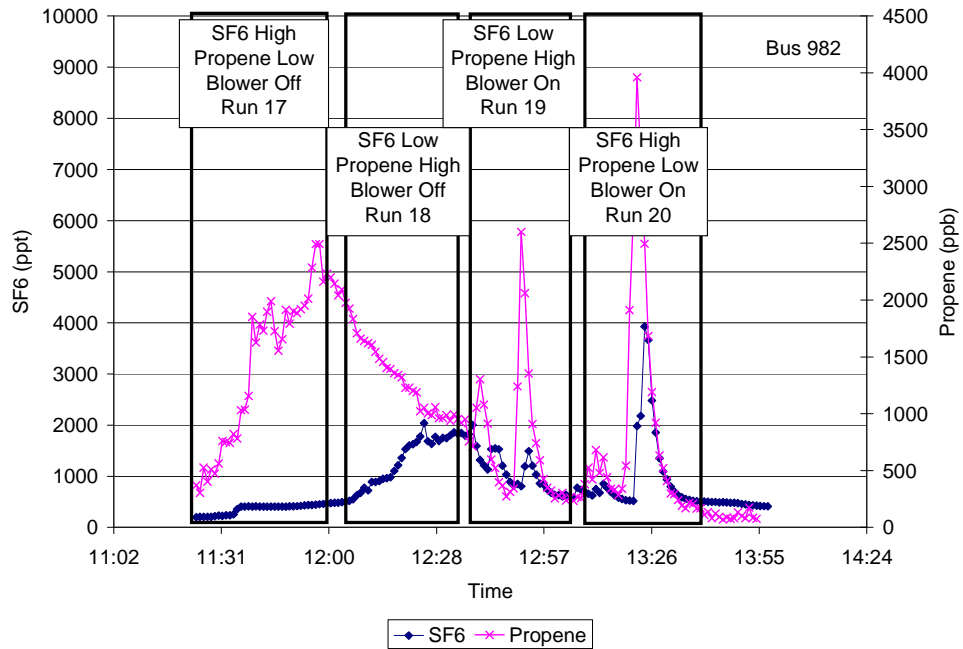
**Table 5.4.1.1.1** Percent self-pollution for individual runs examining the effect of the high exhaust position. SF<sub>6</sub>-H: SF<sub>6</sub> released from high exhaust position; SF<sub>6</sub>-L: SF<sub>6</sub> released from low exhaust position; C<sub>3</sub>H<sub>6</sub>-H: Propene released from high exhaust position; C<sub>3</sub>H<sub>6</sub>-L: Propene released from low exhaust position.

| Test Date (2005) | Run | Self-Pollution (Average Percentage) |                    |                                  |                                  | Percent Change in Self-Pollution |
|------------------|-----|-------------------------------------|--------------------|----------------------------------|----------------------------------|----------------------------------|
|                  |     | SF <sub>6</sub> -H                  | SF <sub>6</sub> -L | C <sub>3</sub> H <sub>6</sub> -H | C <sub>3</sub> H <sub>6</sub> -L |                                  |
| 0427             | 45  |                                     | 0.0087             | 0.0017                           |                                  | -80                              |
| 0504             | 56  |                                     | 0.0073             | 0.0026                           |                                  | -64                              |
| 0504             | 57  | 0.0024                              |                    |                                  | 0.0055                           | -55                              |
| 0510             | 60  |                                     | 0.0095             | 0.0005                           |                                  | -95                              |
| 0510             | 61  | 0.0075                              |                    |                                  | 0.0035                           | +112                             |
| 0511             | 64  |                                     | 0.0044             | 0.0005                           |                                  | -87                              |
| 0511             | 65  | 0.0024                              |                    |                                  | 0.0037                           | -35                              |

Figure 5.4.1.1.2 presents SF<sub>6</sub> and propene concentration time series for four consecutive runs on 0406. Day 0406 was not included in the quantitative analysis, as the bus was not flushed between runs, nor was the blower exhaust covered. If we compare the first two runs of 0406, self-pollution increased when SF<sub>6</sub> tracer gas was released from the low exhaust position during the second run. Similarly, when propene tracer gas was released from the low exhaust position, increased self-pollution was observed as well. A steady decrease in propene tracer gas concentrations was

observed when propene release was switched from the low to the high position. When SF<sub>6</sub> was released from the high exhaust position concentrations remained low, indicating the high exhaust position was effective in lowering self-pollution. However, since the bus was not flushed completely between runs, it was difficult to quantitatively determine if propene levels in the second run would have been as low as the SF<sub>6</sub> concentrations in the first run.

In summary, for self-pollution, releasing the exhaust at a high position, above the bus roof, was effective in facilitating the movement of exhaust away from the bus. Results showed a significant reduction in self-pollution (60% reduction on average) while the bus was in motion on the arterial roads of Route 1.



**Figure 5.4.1.1.2** Time series for SF<sub>6</sub> and propene concentrations on 0406. The bus was not flushed of tracer gas for these runs.

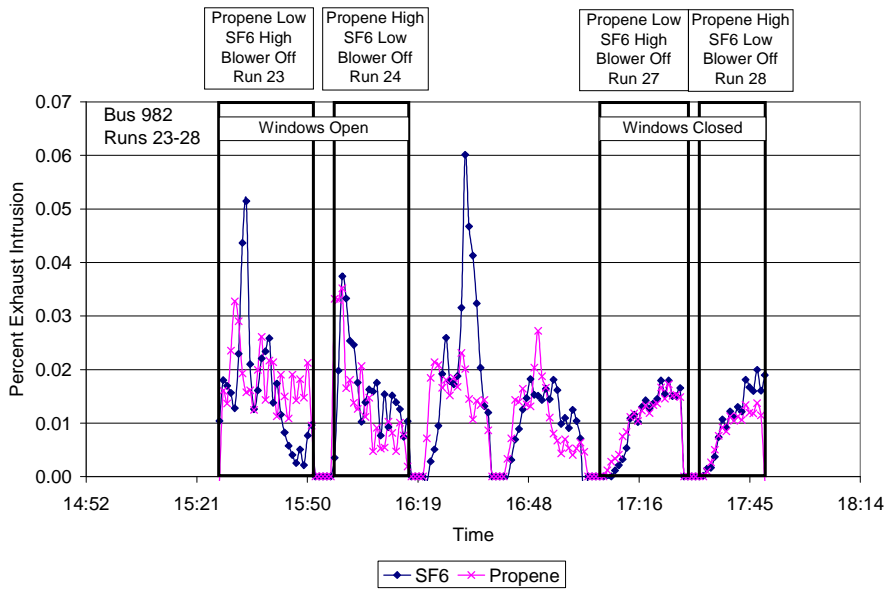


#### 5.4.1.2 Effect of High Exhaust Position in Leader Bus on Follower Bus

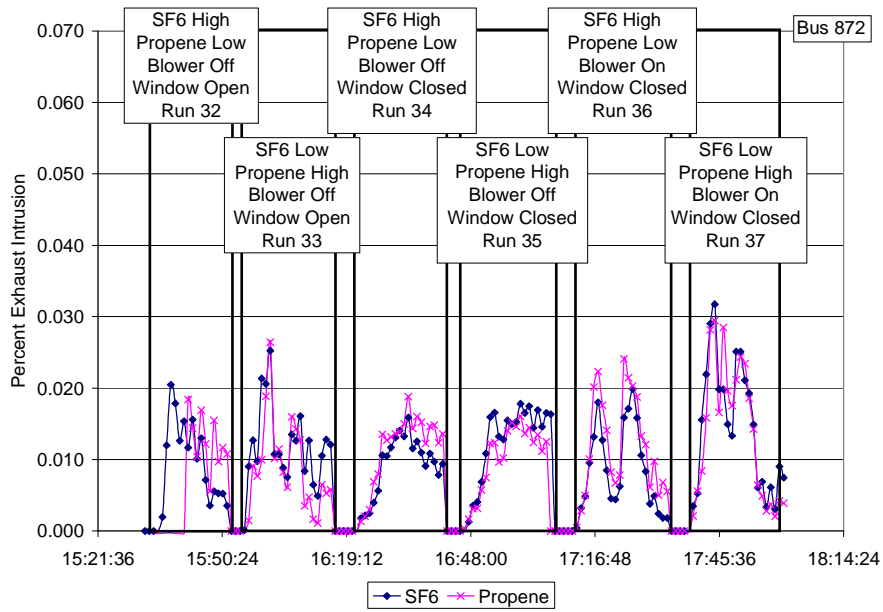
It is important to note that exhaust intrusion into the follower bus, not self-pollution, was evaluated in the leader exhaust experiments when both tracer gas release systems were outfitted on the leader vehicle (another diesel bus) (see Photograph 4.2.4.4.1). Two days of leader exhaust testing were conducted on Route 1 described in Section 4.1.3.1.

In these experiments, we evaluated the effect of exhaust position in the leader bus and window position in the follower bus on exhaust intrusion potential from a leader vehicle into the follower (instrumented) bus. We expected to see substantial exhaust intrusion from the leader bus when follower bus windows were open, but reduced intrusion of the leader bus exhaust with follower bus windows closed or when the leader exhaust position was high.

Figure 5.4.1.2.1 and 5.4.1.2.2 shows time series for a leader exhaust test on 0412 and 0420, respectively. In Figure 5.4.1.2.1, we examined the first two and the last two runs of the day (Runs 23, 24, and Runs 27, 28, respectively), and found for both open and closed window positions on the follower bus, the high exhaust position in the leader bus did not appear to have an effect on exhaust intrusion from the leader bus into the follower bus, compared to the low exhaust position. (Note: the blower exhaust was not covered during the leader exhaust runs; the runs affected by the uncovered blower exhaust were the closed window runs as exhaust could potentially enter the bus cabin. However, this is not a concern for runs conducted with open windows or runs with the blower on.) Thus, exhaust could potentially enter the cabin even though the windows were closed. However, in Figure 5.4.1.2.2, differences between high and low exhaust on the leader bus can be seen in Runs 34 and 35. Although the differences are slight, the low exhaust position on the leader bus appears to result in higher exhaust intrusion compared to the high exhaust position for both tracer gases. Transient but high tracer gas concentrations were evident throughout all 0412 and 0420 runs except when windows were closed on the follower bus. In Runs 27, 28, and 34, 35, exhaust from the leader bus accumulated in the follower bus over the duration of the run, possibly entering the cabin through the front door, blower exhaust port, or other openings. However, the highest tracer gas concentrations observed inside the follower bus with windows closed were only about half the highest concentrations observed with windows open. This indicates closed windows may be somewhat effective in reducing exhaust intrusion from a leader vehicle compared to open windows by preventing the exhaust plume from directly entering the follower bus.



**Figure 5.4.1.2.1** Time series for percent exhaust intrusion by SF<sub>6</sub> and propene on 0412 (leader exhaust test).



**Figure 5.4.1.2.2** Time series for percent exhaust intrusion by SF<sub>6</sub> and propene on 0419 (leader exhaust test).

## 5.4.2 Effect of Power Ventilation (Blower) When Bus in Motion

The goal of these experiments was to slightly pressurize the bus cabin, bringing outside air from the roof of the bus (near the front of the bus) into the cabin to prevent and/or reduce self-pollution with a blower operating at a nominal flow rate. As discussed earlier, this was accomplished by attaching the blower inlet to a ten-inch diameter tube, the end of which was either connected to the roof at the front of the bus, or extended through a bus window (see Photograph 4.2.4.3.2.2). For these experiments windows remained closed. The differences in these two blower inlet positions did not appear to affect the results.

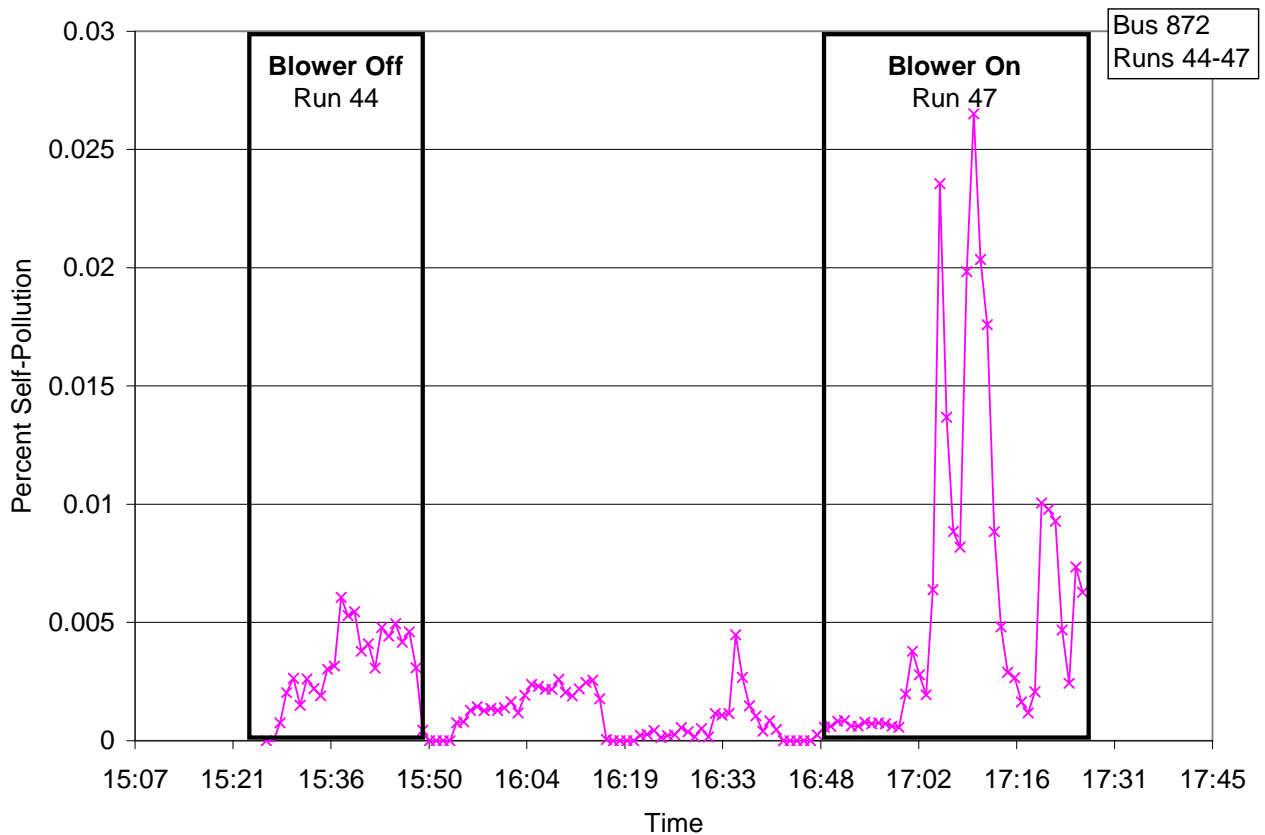
### 5.4.2.1 Effect of Power Ventilation on Self-Pollution when Bus in Motion, Low Exhaust Location

The effect of power ventilation on average self-pollution is shown in Table 5.4.2.1.1 for six pairs of runs. For each pair, one run was conducted for blower on and another run was conducted with blower off, on the same day. Again, the data presented here are from the last five days of testing. Use of the blower resulted in a 40% to 360% decrease in self-pollution compared with no blower.

Overall, power ventilation lowered self-pollution; however, the use of the blower also resulted in high transient peaks in tracer gas concentration in the bus cabin (compared to no blower) as illustrated in Figure 5.4.2.1.1. This may be the result of the buses own exhaust plume passing over the inlet of the blower resulting in exhaust being brought into the bus cabin. This effect is also illustrated in Figure 5.4.2.1.2 when comparing Runs 17 and 20, and 18 and 19. In Runs 19 and 20, the use of the blower results in high, but transient peaks not present when the blower is off.

**Table 5.4.2.1.1** Self-pollution (average percentage) due to power ventilation when tracer gases are released from low exhaust position.

| Test Date (2005) | Runs  | Self-Pollution (Average Percentage) |           | Percent Change In Self-Pollution |
|------------------|-------|-------------------------------------|-----------|----------------------------------|
|                  |       | Blower Off                          | Blower On |                                  |
| 0427             | 45,46 | 0.0087                              | 0.0061    | -43                              |
| 0503             | 52,55 | 0.0073                              | 0.0041    | -78                              |
| 0503             | 53,54 | 0.0190                              | 0.0100    | -81                              |
| 0504             | 56,59 | 0.0072                              | 0.0019    | -280                             |
| 0510             | 60,63 | 0.0095                              | 0.0049    | -94                              |
| 0511             | 65,66 | 0.0037                              | 0.0008    | -360                             |

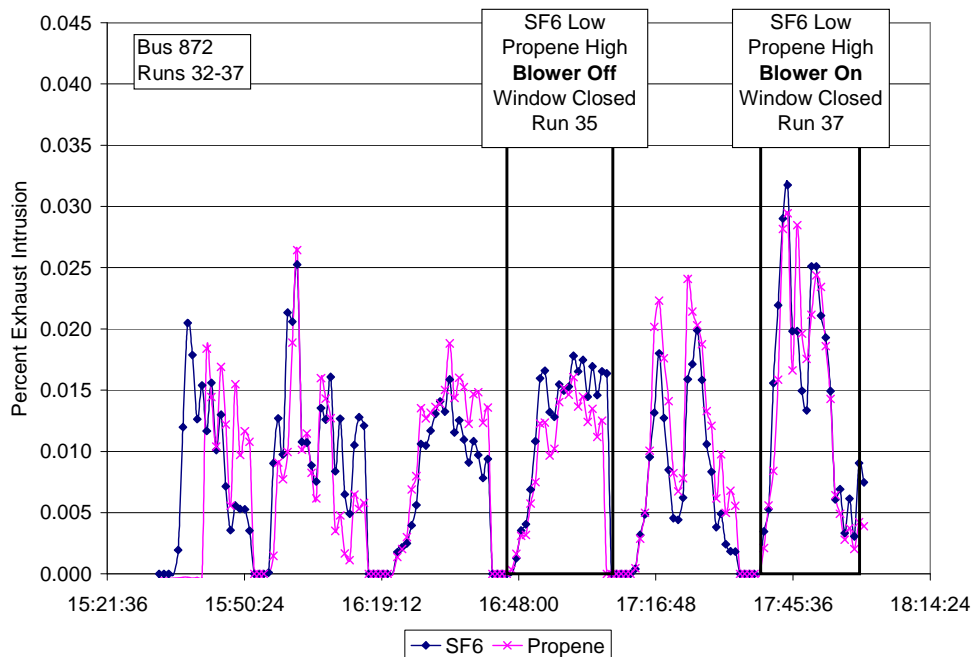


**Figure 5.4.2.1.1** Time series for percent self-pollution by propene on 0427. The boxed areas represent runs where power ventilation was tested.

### 5.4.2.2 Effect of Power Ventilation in the Test Bus while Following a Leader Bus with Low Exhaust

For these tests, propene and SF<sub>6</sub> tracer gas were released from the leader bus at both high and low exhaust positions. In this analysis we focused on the effect of the low exhaust position in the leader bus and the use of power ventilation on the follower bus (with follower bus windows closed).

Figure 5.4.2.2.1 shows a time series on 0419 comparing conditions when the blower was or was not in operation in the follower bus. When the blower was off (Run 35), exhaust intrusion from the leader bus was near constant throughout the run. The highest concentrations observed in the follower bus for these conditions were about half the highest concentrations observed when the blower was on. Thus, it appeared keeping the windows closed was a reasonably effective measure to prevent exhaust intrusion from a leader vehicle being followed for a short time. However, when the blower was on (Run 37), we observed exhaust intrusion from the leader bus in the follower bus; peaks in tracer gas concentration are seen during this period, indicating the blower may not be an effective mitigation strategy to prevent exhaust intrusion from a leader bus.



**Figure 5.4.2.2.1** Time series for percent exhaust intrusion by SF<sub>6</sub> and propene on 0419 during a leader exhaust test. The boxed areas represent runs when power ventilation was tested.

### 5.4.3 Combination of High Exhaust and Power Ventilation (Blower) When Driven on the Test Route

In these experiments, tracer gas release from the high exhaust position was simultaneously tested with power ventilation on our test bus. These runs were conducted with closed windows to test for self-pollution.

#### 5.4.3.1 Effect of Combined High Exhaust and Power Ventilation on Self-Pollution

We expected the combined mitigation strategies of high exhaust and power ventilation to act synergistically to reduce self-pollution, but this was not the case. Tables 5.4.3.1.1 and 5.4.3.1.2 show self-pollution data for the last five days of the study. The tables present two different comparisons to analyze the effect of the combined mitigation strategies. In Table 5.4.3.1.1 we examine the effect of blower operation (on/off) when the exhaust position is high. When the blower was on and the exhaust position was high, about half of the runs showed a decrease in self-pollution, half showed an increase in self-pollution, and in two runs, self-pollution decreased substantially. However, the +2300 % change from run 60 to 63 was strongly dependent on the relatively high uncertainty in the very low self-pollution measured with blower off (0.0005%).

Table 5.4.3.1.2 examines the effect of exhaust position when the blower is in operation. When the blower was on, switching from a low to high exhaust position showed much less benefit than when the blower was off.

Figure 5.4.3.1.1 shows a time series for SF<sub>6</sub> and propene on 0510, illustrating the effect of combining high exhaust with power ventilation (shown in the latter two runs). During these runs, high peak concentrations inside the bus occurred when either SF<sub>6</sub> or propene was released from the high exhaust position. Figure 5.4.3.1.2 illustrates a similar effect. Note different scales are used for the tracer gases. For both tracer gases, release from the high position resulted in transient high concentrations, compared to the low exhaust position. It is not clear why propene intrusion was low on this day compared to other days. However, the figure does show utilizing high exhaust and the blower may have a negative effect, increasing self-pollution.

A possible explanation for these high concentrations is the combination of high exhaust position, wind direction, and movement of the bus has the potential to bring in large amounts of exhaust into the cabin via the blower inlet at the roof of the bus. While this phenomenon occurs for the low exhaust position as well, it is particularly striking for the high exhaust position. This is illustrated in Figure 5.4.3.1.1, Run 63, when propene was released from the high exhaust position. In the previous study (Sabin et al., 2005a, b) SF<sub>6</sub> tracer was observed at the front of the cabin when buses stopped at lights or bus stops with the wind from the rear of the bus, or when the bus was moving slowly in highly congested traffic, again, with the wind from the rear of the bus. These results are consistent with observed in the current study when exhaust appeared to enter the bus through the blower intake when the blower was on.

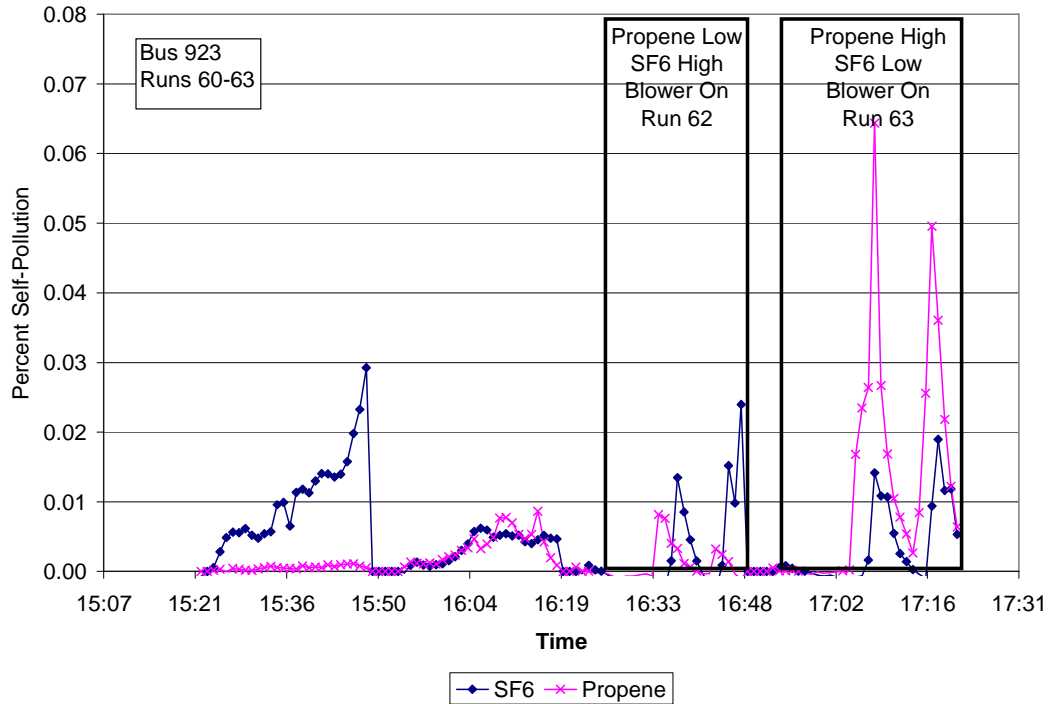
Overall, the combination of the two mitigation strategies, high exhaust and blower, was counterproductive as it resulted in increased tracer gas levels inside the bus for several runs. In particular, the use of power ventilation facilitated the entry of the bus's own exhaust into the bus cabin creating increased self-pollution, reducing its usefulness as a mitigation strategy, especially in combination with a high exhaust position.

**Table 5.4.3.1.1** Self-pollution (average percentage) for individual runs examining the effect of the high exhaust position and blower operation mode.

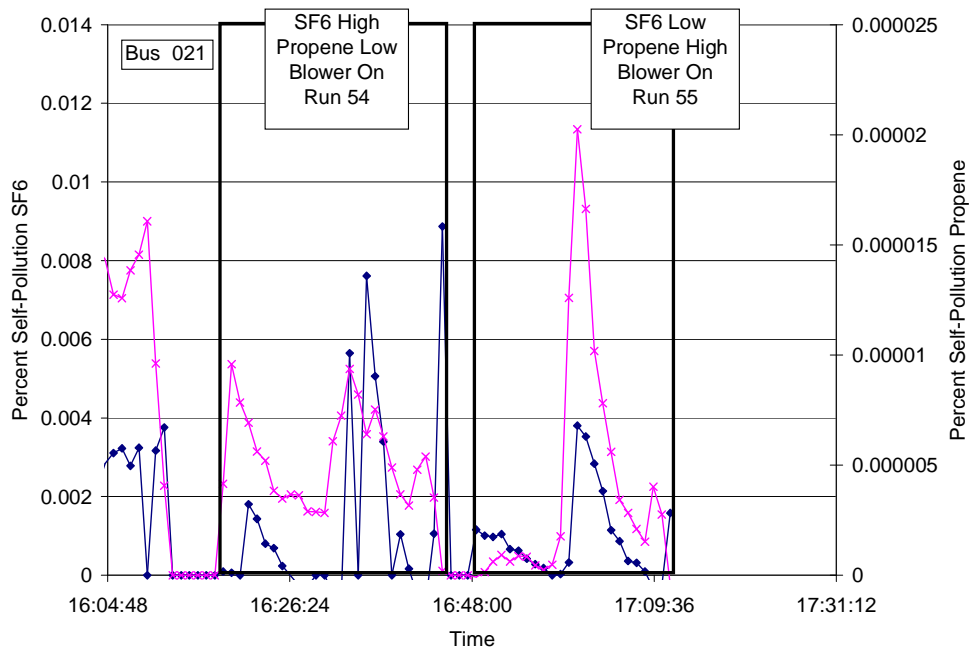
| Test Date | Run   | Window | Self-Pollution (Average Percentage) |           | Percent Change in Self-Pollution |
|-----------|-------|--------|-------------------------------------|-----------|----------------------------------|
|           |       |        | Blower Off                          | Blower On |                                  |
| 0427      | 45,46 | Closed | 0.0017                              | 0.0009    | -47                              |
| 0503      | 52,55 | Closed | 0.0130                              | 0.0080    | -39                              |
| 0504      | 56,59 | Closed | 0.0026                              | NA        | NA                               |
| 0504      | 57,58 | Closed | 0.0024                              | 0.0042    | +75                              |
| 0510      | 60,63 | Closed | 0.0005                              | 0.0120    | +2300                            |
| 0511      | 65,66 | Closed | 0.0024                              | 0.0054    | +130                             |

**Table 5.4.3.1.2** Self-pollution (average percentage) for individual runs examining the effect of high versus low exhaust position when the blower was in operation.

| Test | Run | Blower | Self-Pollution (Average Percentage) |                    |                                  |                                  | Percent Change in Self-Pollution |
|------|-----|--------|-------------------------------------|--------------------|----------------------------------|----------------------------------|----------------------------------|
|      |     |        | SF <sub>6</sub> -H                  | SF <sub>6</sub> -L | C <sub>3</sub> H <sub>6</sub> -H | C <sub>3</sub> H <sub>6</sub> -L |                                  |
| 0427 | 46  | On     |                                     | 0.0061             | 0.0009                           |                                  | -85                              |
| 0427 | 47  | On     | 0.0072                              |                    |                                  | 0.0057                           | +26                              |
| 0503 | 54  | On     | 0.0072                              |                    |                                  | 0.0100                           | -28                              |
| 0503 | 55  | On     |                                     | 0.0041             | 0.0080                           |                                  | +95                              |
| 0504 | 58  | On     | 0.0042                              |                    |                                  | NA                               | NA                               |
| 0504 | 59  | On     |                                     | 0.0019             | NA                               |                                  | NA                               |
| 0511 | 66  | On     | 0.0054                              |                    |                                  | 0.0008                           | +580                             |



**Figure 5.4.3.1.1** Time series of percent self-pollution for SF<sub>6</sub> and propene on 0510 examining the combination of exhaust position and blower operation as a mitigation measure.



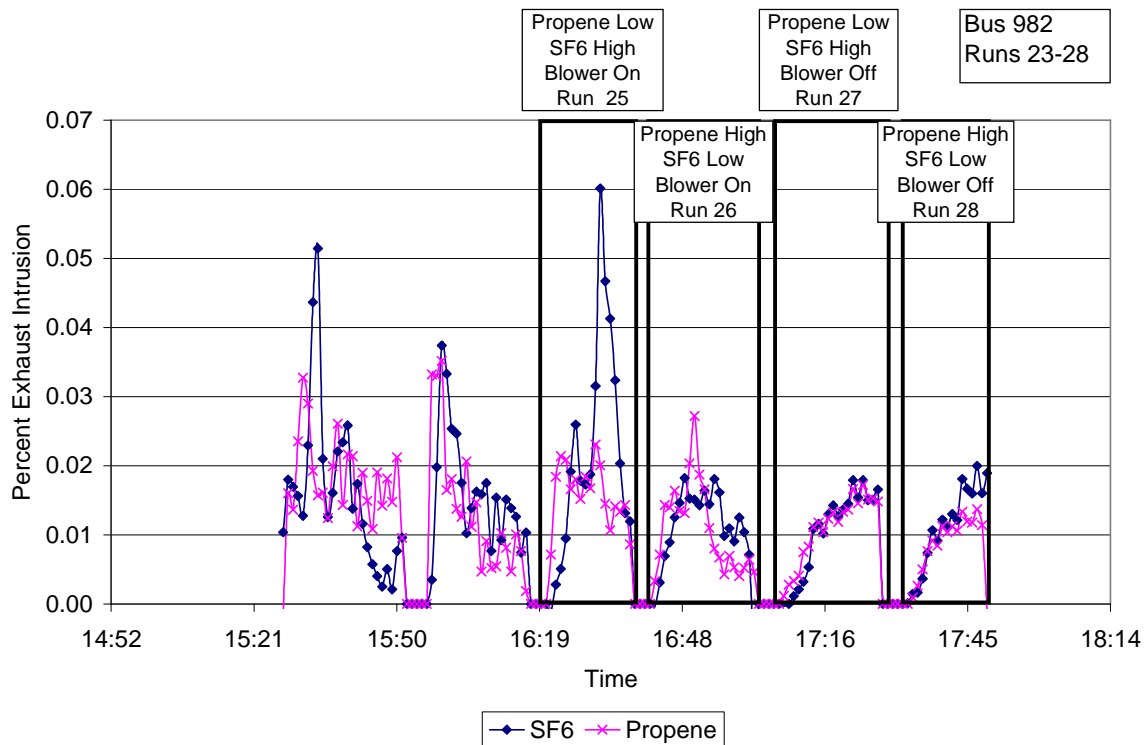
**Figure 5.4.3.1.2** Time series of percent self-pollution for SF<sub>6</sub> and propene on 0503 examining the combination of exhaust position and blower operation as a mitigation measure.



### 5.4.3.2 Effect of Combined High Exhaust in Leader Bus and Power Ventilation on Follower Bus

For this analysis we investigated the use of power ventilation (windows closed) in the follower bus and high exhaust position in the leader bus.

Overall, the use of a blower on the follower bus combined with the high exhaust position on the leader bus did not reduce exhaust intrusion from the leader bus. Figure 5.4.3.2.1 shows when the blower was on (Runs 25, 26), the data were similar to runs conducted with windows open on the follower bus (first two runs of the day-not labeled). Here, exhaust position appears to have a slight affect; for Runs 25 and 26, the high exhaust position results in higher peak concentrations compared to the low exhaust position for both tracer gases. Also, if we compare Runs 25 to Run 27 and Run 26 to Run 28 we observe that in both cases, the blower on condition results in increased exhaust intrusion compared to blower off. Thus, the data appear to be consistent with the blower pulling in exhaust from the leader vehicle. Similar results were observed for the leader exhaust runs conducted on 0419 (Figure 5.4.1.2.2).

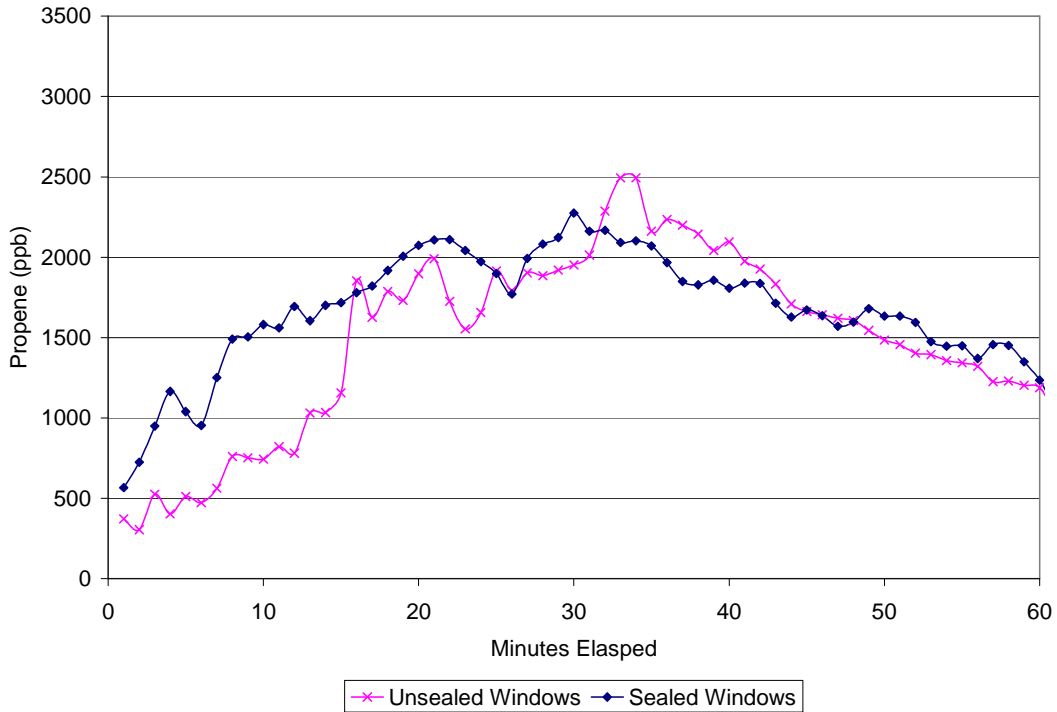


**Figure 5.4.3.2.1** Time series of percent exhaust intrusion for SF<sub>6</sub> and propene during a leader exhaust run conducted on 0412.

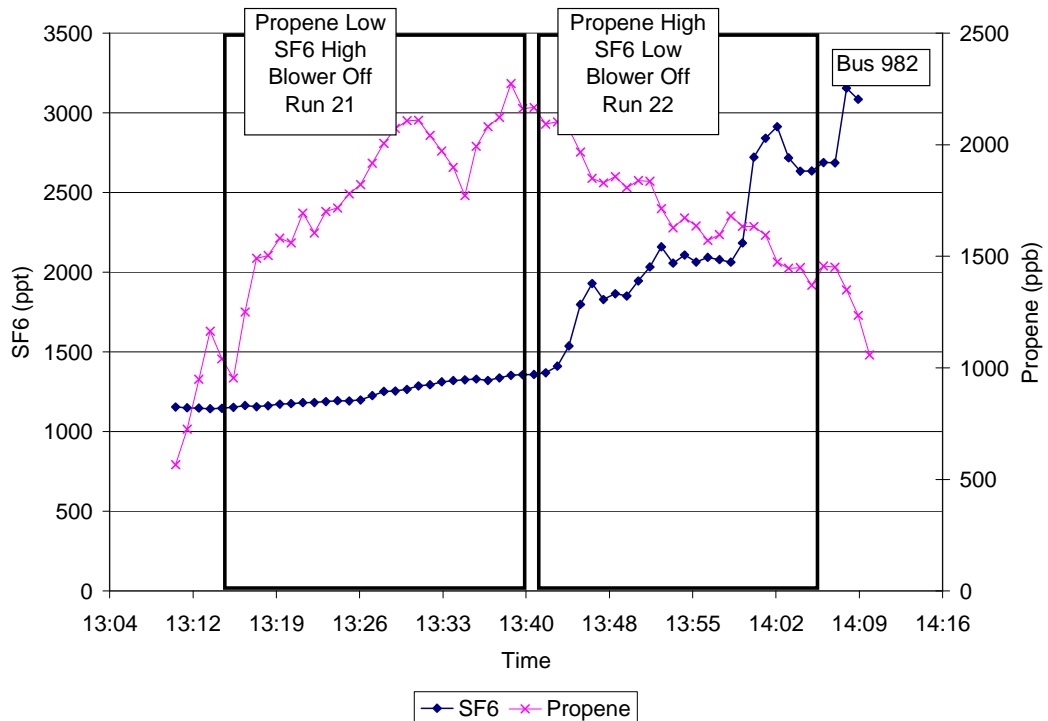
#### 5.4.4 Window Seals

While conducting visual inspections of several buses during the pilot study, we observed large gaps around the door and window frames for many buses, especially older model years. Thus, we expected window areas to be a major entry point for self-pollution, exhaust from surrounding vehicles, and roadway air. Results from the pilot study (attempting to pinpoint intrusion points on the bus) also suggested windows to be a pathway for self-pollution (Fitz et al., 2004). The effect of sealing the bus windows was investigated only on one bus, Bus 982, by taping plastic over all the windows (see Photograph 4.2.4.2.1). The blower was not used in this test.

A comparison of Runs 21 and 22 (windows sealed) with Runs 17 and 18 (windows unsealed) from the previous day shows no significant differences in tracer gas intrusion were observed with windows sealed versus not sealed, as shown in the propene data in Figure 5.4.4.1. SF<sub>6</sub> data were not included in Figure 5.4.4.1 as levels of SF<sub>6</sub> were increased at the start of Run 21 and a comparison between sealed and unsealed windows could not be made. However, a difference between high and low exhaust positions was observed. Although background levels of both tracer gases were increased in Figure 5.4.4.2, the time series resemble the first two runs of 0406 comparing high versus low exhaust in Figure 5.4.1.1.2. In Figure 5.4.4.2, a steady increase in propene concentrations was observed in the first run, when propene was released from the low exhaust position. When propene was released from the high exhaust position in the second run, we observed a steady decrease in propene concentrations indicating the bus was flushing tracer gas from the cabin. The same trends were seen for SF<sub>6</sub>. When SF<sub>6</sub> was released from the low exhaust position, concentrations increased over the course of the run. When SF<sub>6</sub> was released from the high exhaust position in the first run, concentrations remained relatively low. These results, when compared to a run with unsealed windows as on 0406, suggest gaps around the windows were not the primary mechanism for self-pollution. Other entry points may include the rear door, the rear seat(s), bolts, or the floorboards.



**Figure 5.4.4.1** Average propene tracer gas concentrations (by exhaust position) in the bus cabin for windows sealed (0407) versus unsealed (0406).



**Figure 5.4.4.2** Time series for SF<sub>6</sub> and propene concentrations during window seal test on 0407<sup>1</sup>.

<sup>1</sup> The run started with initially high concentrations of tracer gas due to releases of tracer gases into the bus prior to the beginning of the run that we were not able to conveniently flush out after we had applied plastic wrap to the windows. This resulted in only a positive shift of the tracer gas baseline. The tracer gas data were not compromised.

## 5.5 Leader Exhaust-Follower Exhaust Experiments

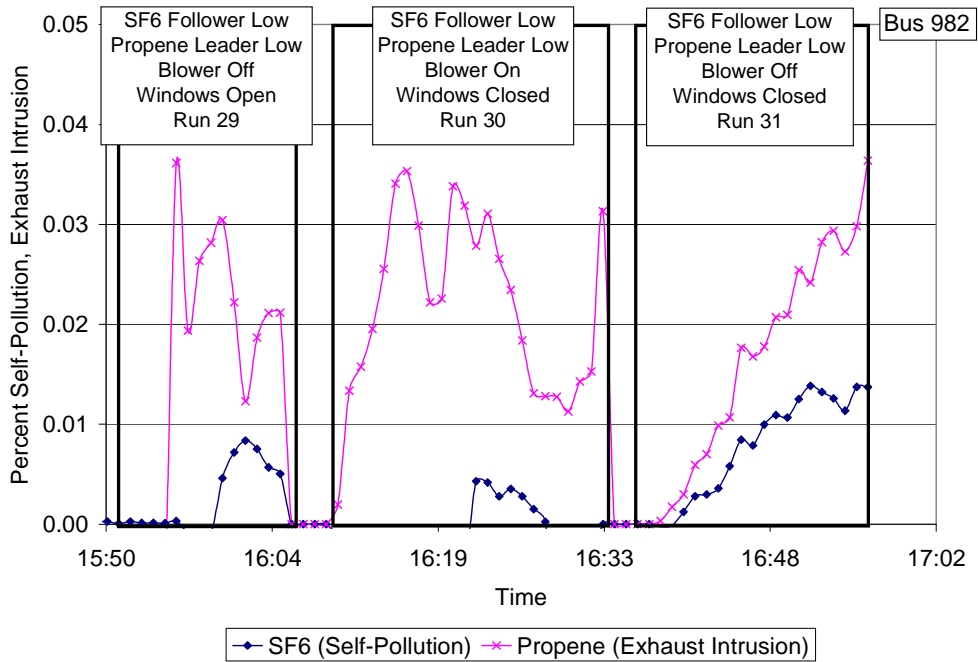
The leader exhaust-follower exhaust experiments evaluated the relative importance of exhaust intrusion from a leader bus versus self-pollution in a follower bus (test bus). In these experiments, SF<sub>6</sub> was released from the low exhaust position of the follower vehicle and propene was released from the low exhaust position of the leader vehicle. We also investigated the effect of window position and blower operation in the follower bus.

Figure 5.5.1 shows time series data for one day of leader exhaust-follower exhaust experiments (Day 0413, follower bus-Bus 982). These data were consistent with self-pollution being higher when windows were closed, as reported in our earlier study (Fitz et al., 2003; Sabin et al., 2005 a, b). When the windows were open, high ventilation rates kept self-pollution (as measured by SF<sub>6</sub>) low, while allowing intrusion of propene tracer gas from the leader bus (Run 29). In Run 31, the follower bus windows were closed and self-pollution in the follower bus increased as expected. However, exhaust intrusion from the leader bus (propene tracer) also increased and at a higher rate than self-pollution. Because the blower exhaust was mistakenly uncovered for runs 29 and 31, this may have contributed to the increased exhaust intrusion for run 31. However, the increased rate of leader bus exhaust intrusion may have been due to the relatively close following distance maintained by the follower bus. At times the buses followed each other similar to caravanning buses from a school.

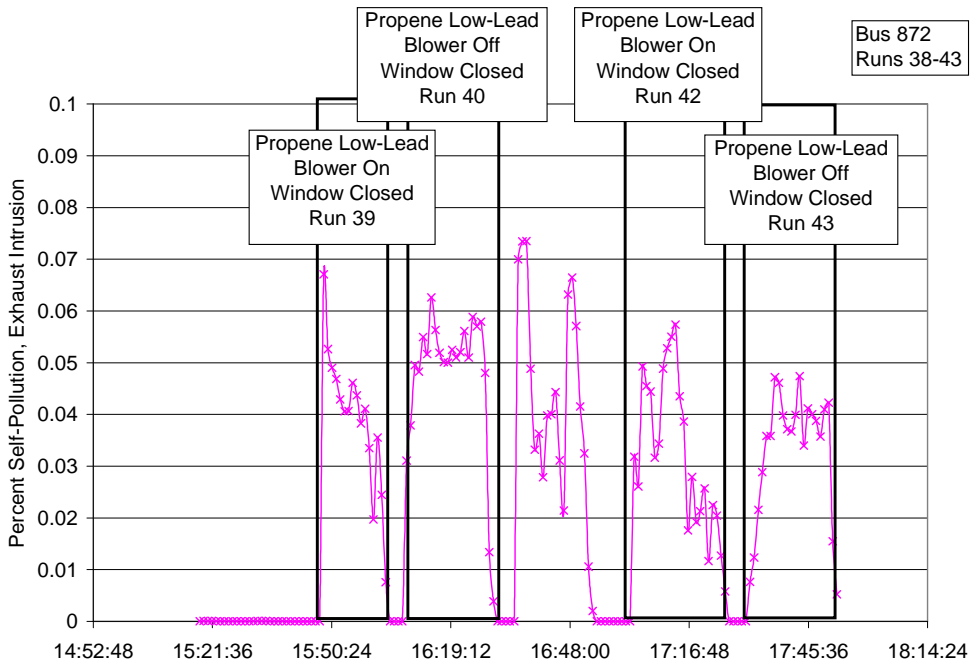
When the follower bus windows were closed and the blower on (Run 30), we observed the accumulation of leader bus exhaust tracer gas in the follower bus cabin likely caused by leader exhaust being pulled in by the blower because infiltration at other locations was shown to be reduced or eliminated by the blower pressure. Across all runs shown in Figure 5.5.1, higher intrusion of propene from the leader bus was observed compared to self-pollution from SF<sub>6</sub>. However, Run 31 shows that the difference between leader exhaust intrusion and self-pollution is smaller compared to Runs 29 and 30 with the blower on.

Another example illustrating the effect of power ventilation is shown in Figure 5.5.2. (This particular bus, Bus 872 had a large dynamic range of exhaust flow rates from idle to full throttle. As a result, the concentrations of tracer gas in the exhaust were lower for these runs; cabin concentrations of SF<sub>6</sub> were near the detection limits of the analyzers. Thus SF<sub>6</sub> data were not used for this figure.) During runs conducted with the blower on and windows closed, we observed greater variation in concentrations in Runs 39 and 42 compared to runs with blower off (Runs 40 and 43).

For Runs 29-31 on Bus 982 the data indicate exhaust intrusion from a closely-followed leader vehicle had a larger impact on the follower bus compared to self-pollution. Despite variability in wind direction on 0413, Runs 29-31 (Bus 982) and 0420, Runs 39-43 (Bus 872), impacts due to exhaust intrusion from the leader bus were observed; self pollution was observed during 0413 as well. The use of power ventilation on the follower bus while windows were closed did reduce self-pollution between Run 30 and Run 31. Furthermore, it appeared the effect of power ventilation in the follower bus was similar to opening the bus's windows.



**Figure 5.5.1** Time series of percent self-pollution and exhaust intrusion for SF<sub>6</sub> and propene, respectively, during a leader exhaust-follower exhaust test on 0413.

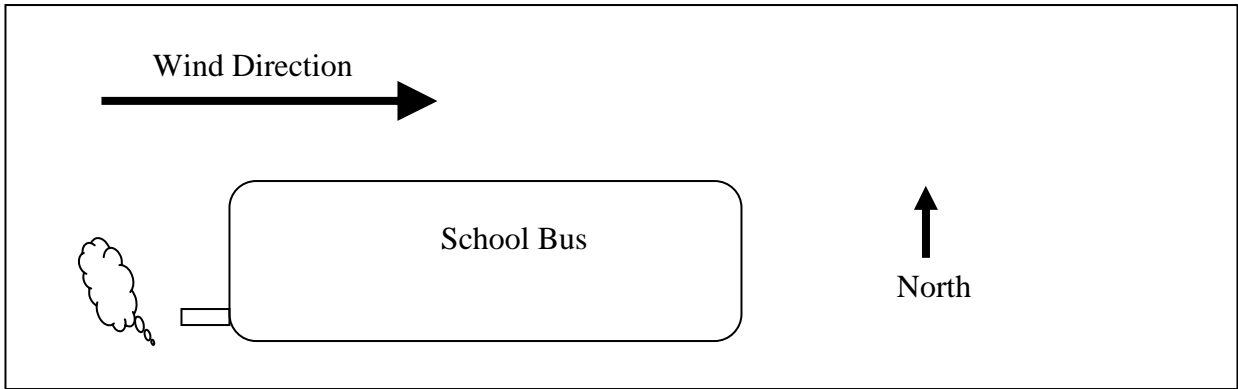


**Figure 5.5.2** Time series of percent self-pollution and exhaust intrusion for propene during a leader exhaust-follower exhaust test on 0420.

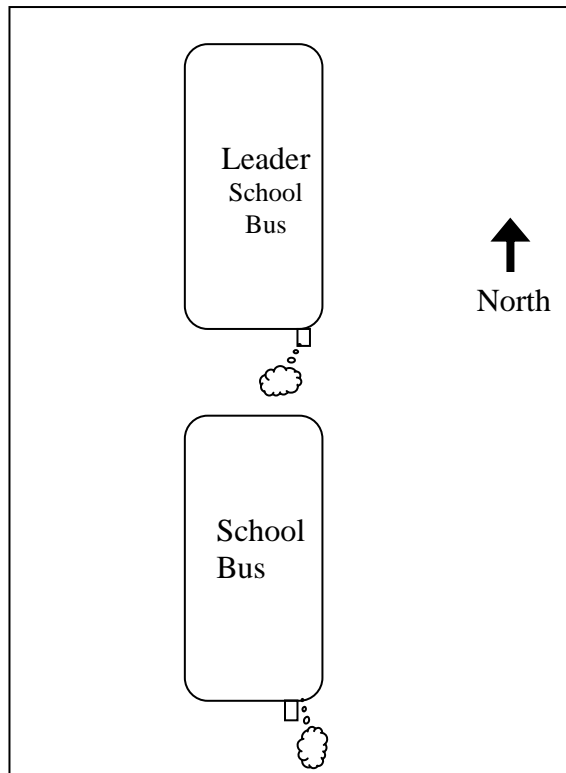
## 5.6 Stationary Runs

Stationary runs were compared and contrasted in the same manner as the mobile runs discussed in previous sections. Blower operation and exhaust position alternated from run to run and the instrumented bus was flushed of tracer gas between each run, except on 0404. The same buses used in the mobile experiments were tested in the stationary runs.

Stationary runs were useful to characterize self-pollution from the bus's own exhaust, as well as exhaust intrusion from a leader bus's exhaust, when buses are stopped at lights, stop signs, or student pick-up or drop-off, or slowed or stopped in heavily congested traffic. During the stationary self-pollution runs, each test bus was parked at CE-CERT while idling with windows closed. These tests were conducted when winds were not expected to be greater than 2-3 m/s. For the self-pollution runs, the buses were oriented in an east-west direction as shown in Figure 5.6.1. Both tracer gas release systems were on the instrumented buses. For leader exhaust stationary runs, the leader bus was parked in front of the follower bus (about 1-2 meters apart) with both buses oriented in a north-south direction as shown in Figure 5.6.2. Although the prevailing winds were from the west for all stationary tests, the space required for aligning the two buses at our test facility necessitated our aligning the buses in a north-south manner. Because the wind conditions during the leader exhaust stationary runs were under 2 m/s and variable (sigma theta of 40-50 degrees for the two periods) the follower bus was exposed to the leader bus's exhaust. Table 5.6.1 describes all stationary runs conducted in the study, including bus number, type of test conducted, window position, tracer gas release positions, and power ventilation mode (blower operation).



**Figure 5.6.1** School bus orientation in relation to wind direction for stationary self-pollution runs.



**Figure 5.6.2** School bus orientation for leader exhaust testing. Both tracer gases are released from the leader bus from a high exhaust position and low exhaust position.

**Table 5.6.1** Description of all stationary runs (conducted in 2005).

| Test Date | Run Number | Bus Number | Type of Experiment             | Window Position | SF <sub>6</sub> Release Position | C <sub>3</sub> H <sub>6</sub> Release Position | Blower |
|-----------|------------|------------|--------------------------------|-----------------|----------------------------------|--|--------|
| 0404      | 1          | 982        | Self-Pollution (Engine Idling) | Closed          | High                             | Low  | Off    |
| 0404      | 2          | 982        | Self-Pollution (Engine Idling) | Closed          | High                             | Low  | On     |
| 0404      | 3          | 982        | Self-Pollution (Engine Idling) | Closed          | Low                              | High   | On     |
| 0404      | 4          | 982        | Self-Pollution (Engine Idling) | Closed          | Low                              | High   | Off    |
| 0404      | 5          | 982        | Self-Pollution (Engine Idling) | Closed          | Low                              | High   | Off    |
| 0404      | 6          | 982        | Self-Pollution (Engine Idling) | Closed          | Low                              | High   | On     |
| 0404      | 7          | 982        | Self-Pollution (Engine Idling) | Closed          | High                             | Low  | On     |
| 0404      | 8          | 982        | Self-Pollution (Engine Idling) | Closed          | High                             | Low  | Off    |
| 0413      | 9          | 982        | Leader Exhaust                 | Open            | High                             | Low  | Off    |
| 0413      | 10         | 982        | Leader Exhaust                 | Open            | Low                              | High   | Off    |
| 0413      | 11         | 982        | Leader Exhaust                 | Closed          | High                             | Low  | On     |
| 0413      | 12         | 982        | Leader Exhaust                 | Closed          | Low                              | High   | On     |
| 0413      | 13         | 982        | Leader Exhaust                 | Closed          | High                             | Low  | Off    |
| 0413      | 14         | 982        | Leader Exhaust                 | Closed          | Low                              | High   | Off    |
| 0420      | 15         | 872        | Leader Exhaust                 | Open            | High                             | Low  | Off    |
| 0420      | 16         | 872        | Leader Exhaust                 | Open            | Low                              | High   | Off    |
| 0420      | 17         | 872        | Leader Exhaust                 | Closed          | High                             | Low  | On     |
| 0420      | 18         | 872        | Leader Exhaust                 | Closed          | Low                              | High   | On     |
| 0420      | 19         | 872        | Leader Exhaust                 | Closed          | High                             | Low  | Off    |
| 0420      | 20         | 872        | Leader Exhaust                 | Closed          | Low                              | High   | Off    |
| 0426      | 21         | 872        | Self-Pollution (Engine Idling) | Closed          | High                             | Low  | Off    |
| 0426      | 22         | 872        | Self-Pollution (Engine Idling) | Closed          | Low                              | High   | Off    |
| 0426      | 23         | 872        | Self-Pollution (Engine Idling) | Closed          | High                             | Low  | On     |
| 0426      | 24         | 872        | Self-Pollution (Engine Idling) | Closed          | Low                              | High   | On     |
| 0504      | 25         | 021        | Self-Pollution (Engine Idling) | Closed          | Low                              | High   | Off    |
| 0504      | 26         | 021        | Self-Pollution (Engine Idling) | Closed          | High                             | Low  | Off    |
| 0504      | 27         | 021        | Self-Pollution (Engine Idling) | Closed          | High                             | Low  | On     |
| 0504      | 28         | 021        | Self-Pollution (Engine Idling) | Closed          | Low                              | High   | On     |
| 0510      | 29         | 923        | Self-Pollution (Engine Idling) | Closed          | Low                              | High   | Off    |
| 0510      | 30         | 923        | Self-Pollution (Engine Idling) | Closed          | High                             | Low  | Off    |
| 0510      | 31         | 923        | Self-Pollution (Engine Idling) | Closed          | High                             | Low  | On     |
| 0510      | 32         | 923        | Self-Pollution (Engine Idling) | Closed          | Low                              | High   | On     |

Meteorological conditions during the stationary runs are shown in Table 5.6.2. Wind speed varied from 1.4 to 2.3 m/s during the run periods for four run days. The three days with winds under 2 m/s provided us with intrusion data for “calm” conditions. The one day with average wind speeds over 2 m/s provided us with intrusion data for these moderate wind speeds.



**Table 5.6.2** Meteorological data during stationary tests (with standard deviations)

| Test Date | Average Wind Speed (m/s) | Average Wind Direction (deg) | Wind Variability Sigma Theta (deg) | Temperature (°C) | Relative Humidity (%) |
|-----------|--------------------------|------------------------------|------------------------------------|------------------|-----------------------|
| 0404      | 2.4 ±0.5                 | 255 ±17                      | 28                                 | 18 ±0.7          | 37 ±4                 |
| 0413      | 1.4 ±0.3                 | 260 ±46                      | 49                                 | 21 ±1.6          | 39 ±5                 |
| 0420      | 1.7 ±0.3                 | 240 ±27                      | 42                                 | 17 ±1.4          | 54 ±9                 |
| 0426      | 1.4 ±0.3                 | 271 ±14                      | 53                                 | 21 ±1.6          | 21 ±1.6               |
| 0504      | 1.6 ±0.30                | 230 ±20                      | 51                                 | 21 ±1.0          | 68 ±5.0               |
| 0510      | 2.3 ±0.3                 | 250 ±23                      | 36                                 | 19 ±0.6          | 41 ±5.0               |

### 5.6.1 Self-Pollution during Stationary Runs

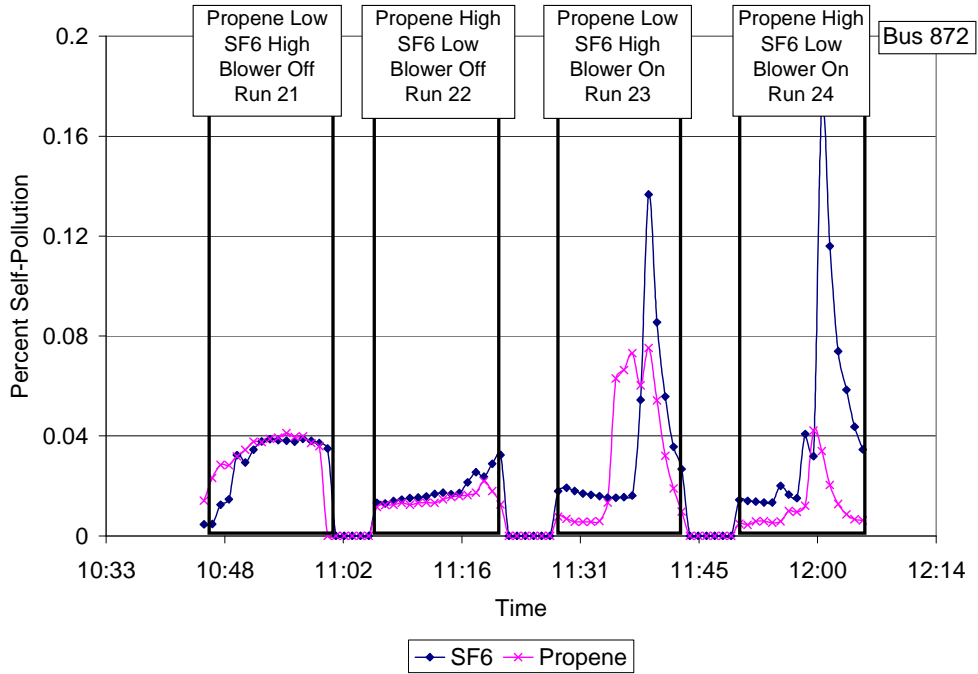
Figures 5.6.1.1 (a-c) present time series graphs for all stationary runs which tested for self-pollution (both tracer gases outfitted on the test bus). The figures show that the self-pollution is fairly consistent between test days. Each time series graph represents testing done on a different bus, thus, differences between test days may be attributed to differences in bus age, bus make, or meteorological effects. Tables 5.6.1.1 through 5.6.1.3 summarize all of the data. Table 5.6.1.2 shows increased self-pollution when the blower is on. Table 5.6.1.1 shows when the blower is off, in most cases the high exhaust position resulted in reduced self-pollution compared to the low exhaust position.

The effect of the high versus low exhaust position during stationary testing is summarized in Table 5.6.1.1. Here, we compare exhaust positions within a single run (SF<sub>6</sub> high and propene low or vice versa, for any given run). In general, the high exhaust position decreased self-pollution by 50%-90% compared to the low exhaust position (although for Run 21, the opposite result was observed and the bus's exhaust was able to reach the cabin).

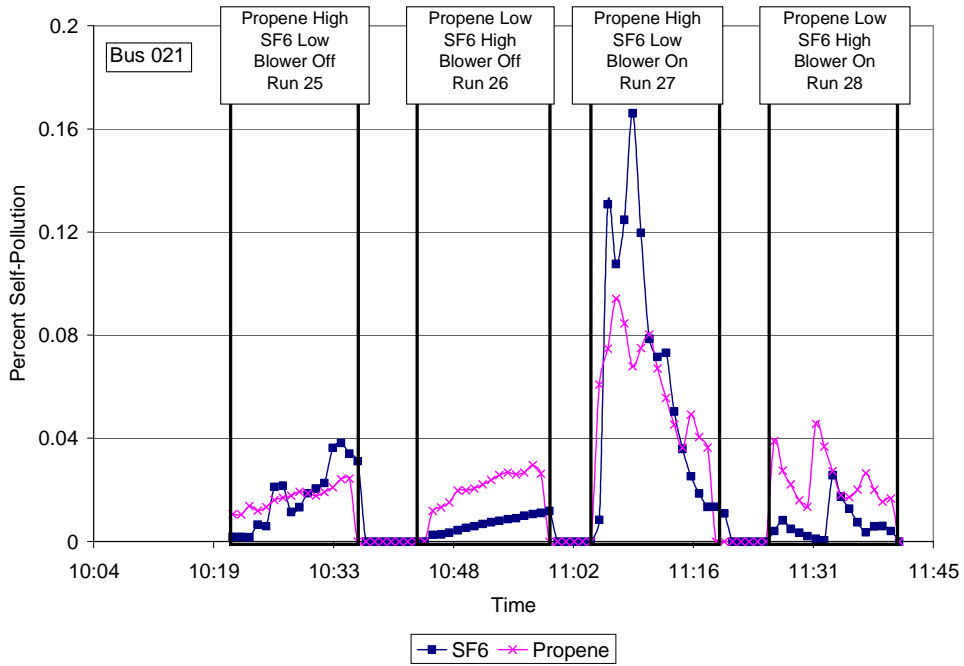
In Table 5.6.1.2 we examined the effect of blower operation. Here, we found the effect of the blower (for the low exhaust position) was highly variable, with a range of 80% decrease to 660% increase in self-pollution. However, the ability of the blower to pull exhaust directly into the bus most likely accounted for the appearance of increased self-pollution in Runs (22, 24) and (26, 27).

Self-pollution data gathered from testing the combined mitigation strategies of high exhaust position and blower operation are presented in Table 5.6.1.3 (a) and Table 5.6.1.3 (b). Data in Table 5.6.1.3 (a) show the effect of exhaust position when the blower was in operation. For Runs 23, 24 and 32 it appeared blower operation decreased intrusion of the bus's own exhaust. In Run 27, 28 and 31 the use of the blower increased self-pollution.

Table 5.6.1.3 (b) shows the effect of blower operation on self-pollution when the exhaust position is high. These data strongly support the findings that the combination of the blower and high exhaust position should not be considered as a mitigation strategy to reduce self-pollution. In Runs (26, 27), use of the blower appeared to have caused almost a twenty-fold increase in intrusion from the bus's own (high) exhaust. In only Runs (22, 24) did the combination of high exhaust and power ventilation decrease self-pollution (by 43%).

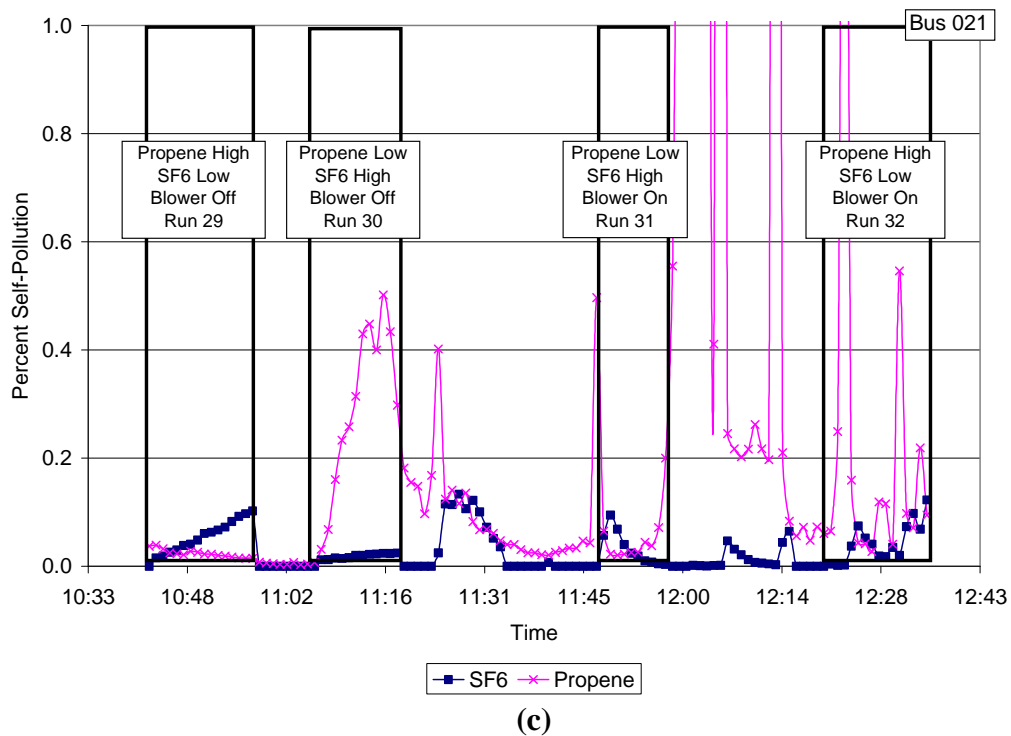


(a)



(b)

**Figure 5.6.1.1 (a, b)** Time series for SF<sub>6</sub> and propene during stationary self-pollution testing on 0426 (a) and 0504 (b).



**Figure 5.6.1.1 (c)** Time series for SF<sub>6</sub> and propene during stationary self-pollution testing 0510.

**Table 5.6.1.1** Average percent self-pollution (relative to low exhaust) and changes in self-pollution for individual stationary runs examining the effect of high versus low exhaust position.

| Test Date (2005) | Run | Self-Pollution (Average Percentage) |                    |                                  |                                  | Percent Change in Self-Pollution |
|------------------|-----|-------------------------------------|--------------------|----------------------------------|----------------------------------|----------------------------------|
|                  |     | SF <sub>6</sub> -H                  | SF <sub>6</sub> -L | C <sub>3</sub> H <sub>6</sub> -H | C <sub>3</sub> H <sub>6</sub> -L |                                  |
| 0426             | 21  | 0.014                               |                    |                                  | 0.028                            | -49                              |
| 0426             | 22  |                                     | 0.0037             | 0.0082                           |                                  | +120                             |
| 0504             | 25  |                                     | 0.015              | 0.007                            |                                  | -52                              |
| 0504             | 26  | 0.0033                              |                    |                                  | 0.011                            | -71                              |
| 0510             | 29  |                                     | 0.041              | 0.0057                           |                                  | -86                              |
| 0510             | 30  | 0.0016                              |                    |                                  | 0.040                            | -61                              |

**Table 5.6.1.2** Average percent self-pollution (relative to blower off) and changes in self pollution for individual stationary runs examining the effect of blower operation with exhaust in low position

| Test Date (2005) | Runs  | Self-Pollution (Average Percentage) |           | Percent Change in Self-Pollution |
|------------------|-------|-------------------------------------|-----------|----------------------------------|
|                  |       | Blower Off                          | Blower On |                                  |
| 0426             | 21,23 | 0.020                               | 0.025     | +11                              |
| 0426             | 22,24 | 0.0057                              | 0.029     | +660                             |
| 0426             | 25,28 | 0.016                               | NA        | NA                               |
| 0426             | 26,27 | 0.012                               | 0.050     | +360                             |
| 0504             | 29,32 | 0.041                               | 0.041     | 0                                |
| 0504             | 30,31 | 0.040                               | 0.0068    | -83                              |

**Table 5.6.1.3 (a)** Average percent self-pollution (relative to low exhaust) for individual stationary runs examining the effect of high versus low exhaust position when the blower was in operation.

| Test Date (2005) | Run | Blower | Self-Pollution (Average Percentage) |                    |                                  |                                  | Percent Change in Self-Pollution |
|------------------|-----|--------|-------------------------------------|--------------------|----------------------------------|----------------------------------|----------------------------------|
|                  |     |        | SF <sub>6</sub> -H                  | SF <sub>6</sub> -L | C <sub>3</sub> H <sub>6</sub> -H | C <sub>3</sub> H <sub>6</sub> -L |                                  |
| 0426             | 23  | On     | 0.02                                |                    |                                  | 0.025                            | -21                              |
| 0426             | 24  | On     |                                     | 0.028              | 0.0057                           |                                  | -80                              |
| 0504             | 27  | On     | 0.065                               |                    |                                  | 0.052                            | +26                              |
| 0504             | 28  | On     |                                     | 0.0031             | 0.015                            |                                  | +370                             |
| 0510             | 31  | On     | 0.032                               |                    |                                  | 0.007                            | +360                             |
| 0510             | 32  | On     |                                     | 0.041              | 0.029                            |                                  | -28                              |

**Table 5.6.1.3 (b)** Average percent self-pollution (relative to blower off) and changes in self-pollution for individual stationary runs examining the effect of blower operation when the exhaust position was high.

| Test Date (2005) | Run   | Self-Pollution (Average Percentage) |           | Percent Change in Self-Pollution |
|------------------|-------|-------------------------------------|-----------|----------------------------------|
|                  |       | Blower Off                          | Blower On |                                  |
| 0426             | 21,23 | 0.014                               | 0.020     | +43                              |
| 0426             | 22,24 | 0.0082                              | 0.0057    | -30                              |
| 0504             | 25,28 | 0.0074                              | 0.015     | +100                             |
| 0504             | 26,27 | 0.0033                              | 0.065     | +1900                            |
| 0510             | 29,32 | 0.0057                              | 0.029     | +410                             |
| 0510             | 30,31 | 0.0016                              | 0.032     | +100                             |

In general, self-pollution was higher in the stationary runs compared with the mobile runs. For example, mobile self-pollution runs testing exhaust position (high versus low with blower off), resulted in mean self-pollution values of 0.0019% and 0.0064% for the high and low exhaust positions, respectively, as measured by SF<sub>6</sub>. In the stationary self-pollution runs, equivalent testing scenarios resulted in mean self-pollution values of 0.020% and 0.022%, for the high and low exhaust positions, respectively, as measured by SF<sub>6</sub>. This three to ten fold increase in self-pollution for stationary runs was expected as calm wind conditions observed in the morning and lack of turbulence (created by moving buses) facilitated self-pollution and exhaust intrusion. Thus, consistent with our earlier study (Sabin et al., 2005a, b), the stationary data suggest there is potential for high self-pollution during bus commutes, when the bus is stopped at a traffic light or stopped in traffic.

## 5.6.2 Exhaust Intrusion during Stationary Leader Exhaust Runs

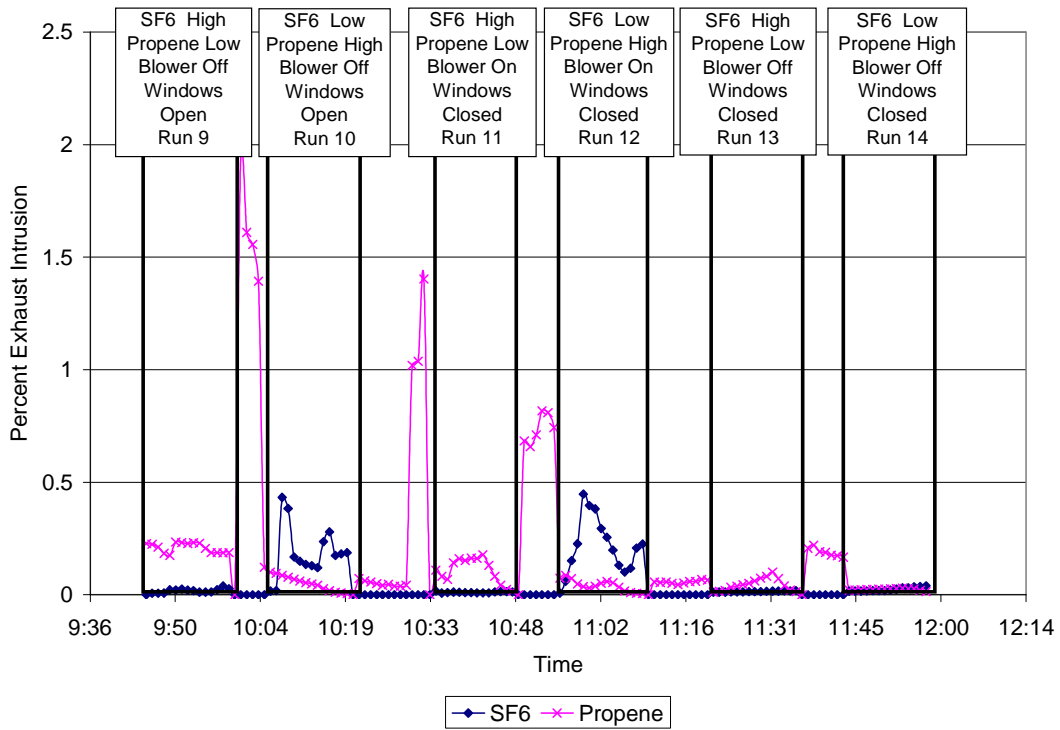
Compared to the mobile leader exhaust runs, the use of the proposed mitigation strategies during stationary leader exhaust runs appeared to be more effective in reducing exhaust intrusion from a leader bus.

Figures 5.6.2.1 and 5.6.2.2 show time series for stationary leader exhaust runs conducted on 0413 and 0420. The results for these two days somewhat differ from the results of the mobile testing. When windows were open (stationary Runs 9-10 and Runs 15-16) a difference between low and high exhaust positions were observed. Tracer gas release from the low exhaust position resulted increases exhaust intrusion. During mobile testing no difference was observed between high and low tracer gas release (Section 5.4.1.2). For stationary leader exhaust runs testing the impact of power ventilation (windows closed, Runs 11-12, 17-18), increases of tracer gas were observed when tracer gas release was low except for propene tracer gas in Run 17 (compared to Run18). The most effective method to prevent exhaust intrusion during stationary leader exhaust runs was when windows were closed and the blower was off.

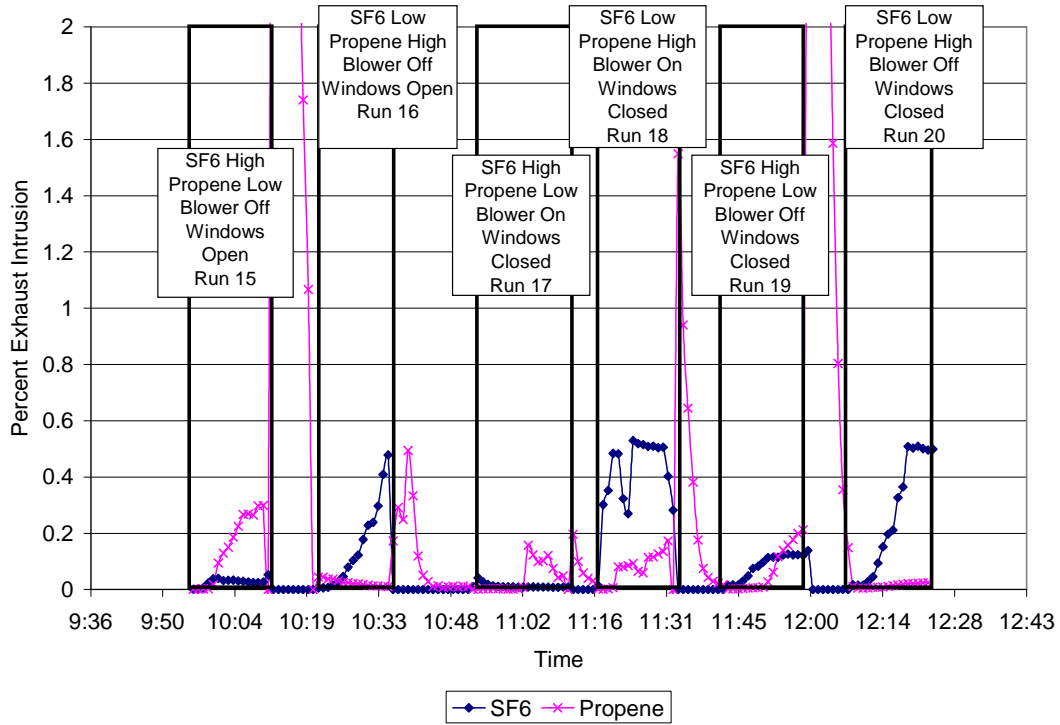
Tables 5.6.2.1-5.6.2.3 summarize exhaust intrusion data from two days of stationary leader exhaust testing. In Table 5.6.2.1, for most runs, the high exhaust position on the leader bus reduced exhaust intrusion in the follower bus by 85% to 95%. In Run 14, exhaust intrusion was increased by 12%. Run 19 showed exhaust position had no effect on exhaust intrusion in the follower bus.

Table 5.6.2.2 shows the effect of a blower in the follower bus in reducing exhaust intrusion from a leader bus. In Runs (19, 17) a modest decrease (40%) in exhaust intrusion was observed. However, use of the blower increased exhaust intrusion for Runs (13, 11) and (20, 18); exhaust intrusion increased substantially in Runs (14, 12).

The combination of the two mitigation measures yielded mixed results. Although the data here are limited in terms of number of runs available for analysis, Table 5.6.2.3a shows exhaust intrusion decreased by up to 91% when utilizing both the blower and high exhaust versus blower on plus low exhaust. However, data in Table 5.6.2.3b show when exhaust position in the leader bus is high, the use of the blower can increase exhaust intrusion up to almost twenty-fold. Thus, while stationary, the use of both mitigation strategies in a leader exhaust configuration can potentially significantly increase exhaust intrusion.



**Figure 5.6.2.1** Time series for SF<sub>6</sub> and propene during stationary exhaust intrusion runs conducted on 0413.



**Figure 5.6.2.2** Time series for SF<sub>6</sub> and propene during stationary exhaust intrusion runs on 0420.

**Table 5.6.2.1** Average percent exhaust intrusion (relative to low exhaust) and percent change in exhaust intrusion from a leader bus measured in the follower bus during stationary leader exhaust runs examining the effect of high versus low exhaust position on a leader bus.

| Test Date (2005) | Run | Window | Blower | Exhaust Intrusion (Average Percentage) |                    |                                  |                                  | Percent Change in Exhaust Intrusion |
|------------------|-----|--------|--------|--|--------------------|----------------------------------|----------------------------------|-------------------------------------|
|                  |     |        |        | SF <sub>6</sub> -H                     | SF <sub>6</sub> -L | C <sub>3</sub> H <sub>6</sub> -H | C <sub>3</sub> H <sub>6</sub> -L |                                     |
| 0413             | 9   | Open   | Off    | 0.086                                  |                    |                                  | 0.210                            | -95                                 |
| 0413             | 10  | Open   | Off    |  | 0.190              | NA                               |                                  | NA                                  |
| 0413             | 13  | Closed | Off    | 0.0047                                 |                    |                                  | 0.041                            | -88                                 |
| 0413             | 14  | Closed | Off    |  | 0.017              | 0.0019                           |                                  | +12                                 |
| 0420             | 15  | Open   | Off    | 0.026                                  |                    |                                  | 0.170                            | -84                                 |
| 0420             | 16  | Open   | Off    |  | 0.014              | NA                               |                                  | NA                                  |
| 0420             | 19  | Closed | Off    | 0.070                                  |                    |                                  | 0.070                            | 0                                   |
| 0420             | 20  | Closed | Off    |  | 0.250              | 0.0014                           |                                  | -94                                 |

**Table 5.6.2.2** Average percent exhaust intrusion (relative to blower off) and percent change in exhaust intrusion from a leader bus measured in the follower bus during stationary leader exhaust runs examining the effectiveness of using the blower in the follower bus in preventing exhaust intrusion from the low exhaust position of the leader bus.

| Test Date (2005) | Runs  | Window | Exhaust Intrusion (Average Percentage) |           | Percent Change in Exhaust Intrusion |
|------------------|-------|--------|--|-----------|-------------------------------------|
|                  |       |        | Blower Off                             | Blower On |                                     |
| 0413             | 13,11 | Closed | 0.041                                  | 0.120     | +190                                |
| 0413             | 14,12 | Closed | 0.017                                  | 0.220     | +1200                               |
| 0420             | 19,17 | Closed | 0.070                                  | 0.042     | -40                                 |
| 0420             | 20,18 | Closed | 0.250                                  | 0.400     | +60                                 |

**Table 5.6.2.3 (a)** Average percent exhaust intrusion (relative to low exhaust) and percent change in exhaust intrusion from a leader bus measured in the follower bus during stationary leader exhaust runs examining the effectiveness of high versus low exhaust position on the leader bus in preventing exhaust intrusion in the follower bus while operating the blower in the follower bus.

| Test Date (2005) | Run | Window | Blower | Exhaust Intrusion (Average Percentage) |                    |                                  |                                  | Percent Change in Exhaust Intrusion |
|------------------|-----|--------|--------|--|--------------------|----------------------------------|----------------------------------|-------------------------------------|
|                  |     |        |        | SF <sub>6</sub> -H                     | SF <sub>6</sub> -L | C <sub>3</sub> H <sub>6</sub> -H | C <sub>3</sub> H <sub>6</sub> -L |                                     |
| 0413             | 11  | Closed | On     | NA                                     |                    |                                  | 0.120                            | NA                                  |
| 0413             | 12  | Closed | On     |  | 0.220              | NA                               |                                  | NA                                  |
| 0420             | 17  | Closed | On     | 0.0037                                 |                    |                                  | 0.042                            | -91                                 |
| 0420             | 18  | Closed | On     |  | 0.400              | 0.082                            |                                  | -80                                 |



**Table 5.6.2.3 (b)** Average percent exhaust intrusion (relative to blower off) and change in percent exhaust intrusion from a leader bus measured in the follower bus during stationary leader exhaust runs examining the effectiveness of blower operation in the follower bus and high exhaust position on the leader bus in preventing exhaust intrusion on the follower bus.

| <b>Test Date<br/>(2005)</b> | <b>Runs</b> | <b>Window</b> | <b>Exhaust Intrusion<br/>(Average Percentage)</b> |                   | <b>Percent Change in<br/>Exhaust Intrusion</b> |
|-----------------------------|-------------|---------------|---|-------------------|--|
|                             |             |               | <b>Blower On</b>                                  | <b>Blower Off</b> |  |
| 0413                        | 13,11       | Closed        | NA  | NA                | NA   |
| 0413                        | 14,12       | Closed        | NA  | NA                | NA   |
| 0420                        | 19,17       | Closed        | 0.07  | 0.0037            | +1800  |
| 0420                        | 20,18       | Closed        | 0.082   | 0.0136            | +500   |

## 5.7 Comparison to Previous School Bus Study

A direct comparison between the current study and our previous school bus (Fitz et al. 2003) study is not possible as the studies were conducted under differing experimental and environmental conditions, and with the exception of Bus 982, with different buses. The previous school bus study found self-pollution to vary by more than an order of magnitude from bus to bus under similar conditions and to also to vary significantly depending on window position and route taken, among other factors.

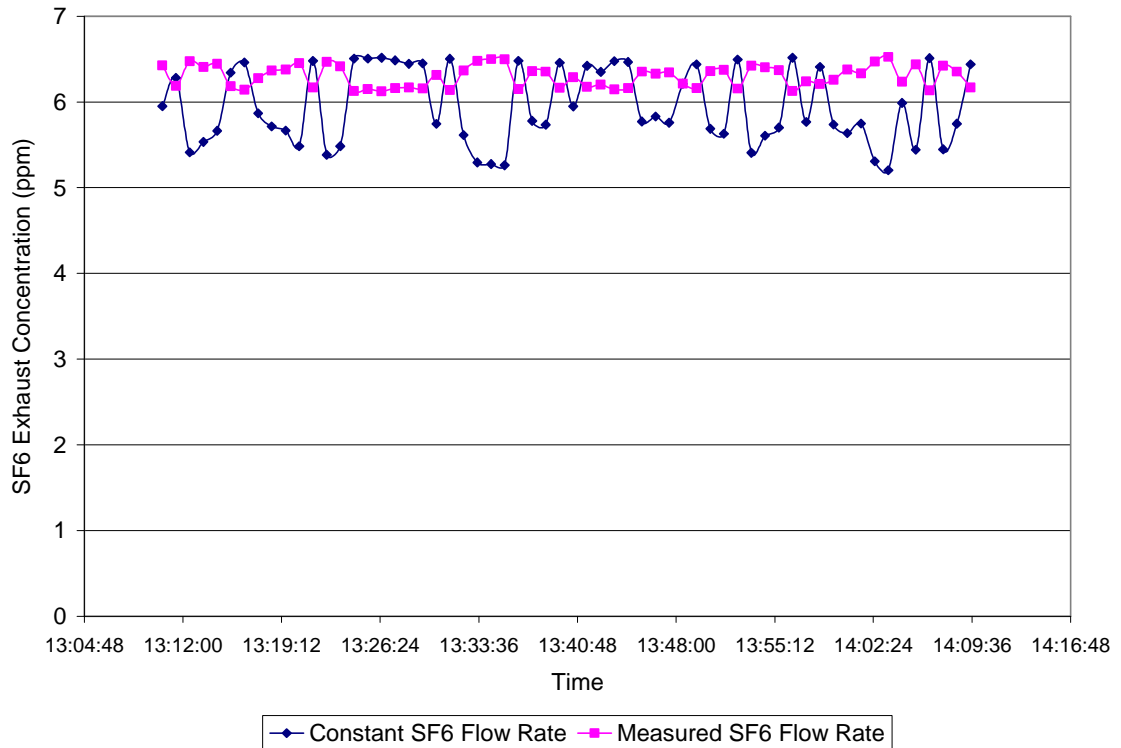
Overall, the self-pollution values obtained in the current study were generally lower than those obtained from our previous school bus study. Self-pollution observed in the “representative” buses in the previous study averaged about 0.02% with the windows closed compared to 0.006% in the current study with the windows closed and without implementation of mitigation strategies. There were, however, major differences between the studies that would impact the degree of self-pollution. These differences included tracer release systems, buses utilized, locations and nature of test routes, traffic densities and average bus speeds, wind speeds and directions, and durations of the test runs. In this section we discuss possible comparisons and how differences between the two studies affected tracer gas concentrations in exhaust, and calculated rates of self-pollution.

### 5.7.1. Comparison of Tracer Gas Release Systems and Tracer Gas Concentrations in Exhaust

Bus 982 in the current study was also used as Bus TO1 in our previous school bus study (Fitz et al. 2003). Thus, qualitative comparisons may be made between the two studies for this bus. The previous study metered a constant flow of SF<sub>6</sub> tracer gas in the bus’s exhaust, resulting in varying SF<sub>6</sub> concentrations in the bus’s exhaust depending on changes in the bus’s exhaust flow rate. The current study improved on this system by metering the tracer gas into the bus’s exhaust in proportion to engine intake flow. The result was a relatively constant concentration of SF<sub>6</sub> tracer gas in the bus’s exhaust.

In the previous study, SF<sub>6</sub> tracer gas was metered into the bus’s exhaust at a constant rate of about 2 lpm. Although exhaust flow measurements were not recorded in our earlier study, it was calculated to be 9 m<sup>3</sup>/min for Bus TO1 (Fitz et al., 2003) based on engine displacement and estimated average rpm. The actual engine intake flow rates measured in the current study allowed more accurate estimation of exhaust flows. Engine intake flow rates measured on 04/07 in the current study for Bus 982 averaged  $8.1 \pm 1.2$  m<sup>3</sup>/min. The difference of about 10% was well within our measurement uncertainty. Based on this agreement, flow estimations from the previous study appear accurate.

Figure 5.7.1 shows the calculated SF<sub>6</sub> tracer gas exhaust concentrations for the run made on 04/07 versus the expected concentrations if tracer gas was released at a constant rate as in the previous study. The calculations were made using 1-minute median flow rates. While the release system used in the current study clearly lowered the concentration variability, with a standard deviation of 2% compared with 7%, the expected variability in our previous study was within our measurement uncertainty, and the run averages agreed to within 6%.



**Figure 5.7.1.** SF<sub>6</sub> tracer gas exhaust concentrations (1-minute medians) for Bus 982/TO1 on run 0407 calculated using measured SF<sub>6</sub> and exhaust flow rates versus those calculated with constant 2 lpm SF<sub>6</sub> flow rate and measured exhaust flow rate.

### 5.7.2. Comparison of Buses and Routes

The previous study found self-pollution rates to be dramatically reduced as bus ventilation rate increased, for example with open windows and/or increased speeds. The highly-congested routes of the previous study resulted in an average speed of approximately 18 mph compared to the 25-30 mph of the lightly-congested routes used in the current study. Therefore, the previous study likely had reduced bus ventilation rates and increased self-pollution due to speed differences.

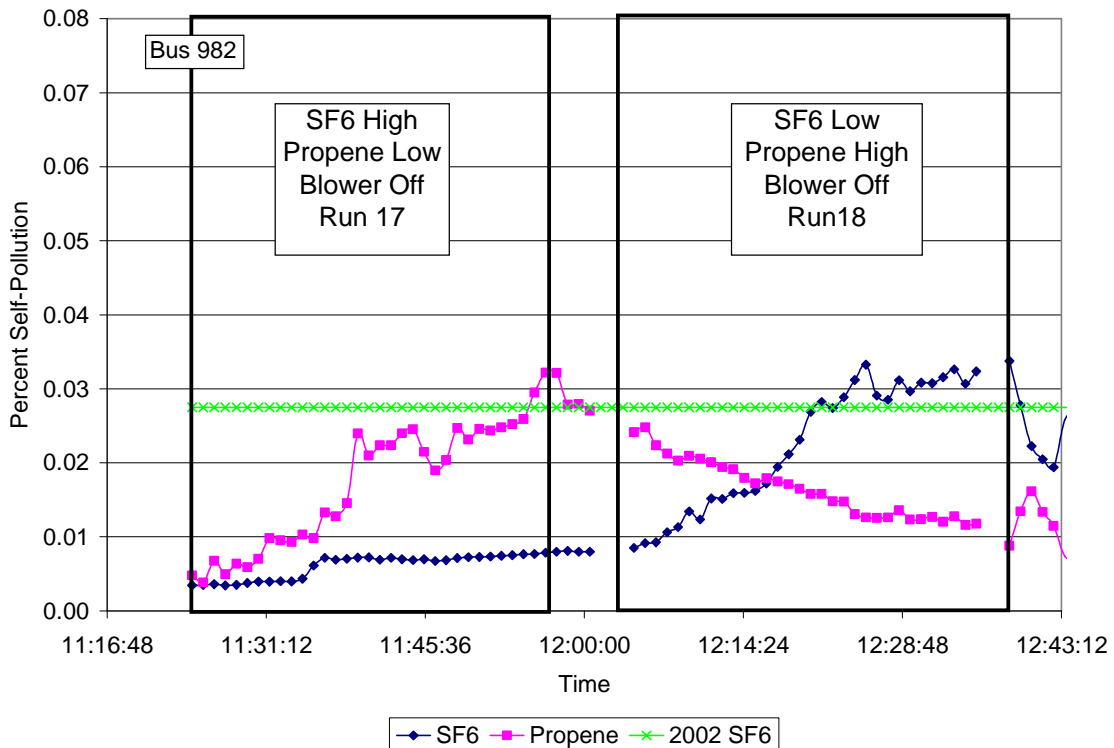
In addition, wind speed is an important factor affecting bus ventilation, particularly at low bus speeds and while idling. The current study runs were only conducted in the early afternoon, when winds were generally highest. During the late spring, when both these studies were conducted, mornings were characterized by calm wind conditions and afternoons were characterized by increased on-shore winds. Thus, in the previous study, low wind speeds (between 0.2 and 1.1 m/s) observed in the early morning hours, in combination with the extensive time spent driving in highly-congested conditions during morning rush hour, increased the potential for self-pollution to occur. During the current study, reduced time stopped due to lack of congestion and increased wind speeds (between 2.6 and 4.0 m/s) in the mid-day and afternoon reduced the potential for self pollution to occur.

### 5.7.3 Effects due to Differences in Run Duration

The time it takes for tracer gas concentrations to reflect the full impact of self-pollution

appears in some cases appears to exceed one-half hour, the duration of tests in the current study. The previous study runs took over one hour, thus potentially allowing higher overall measures of self-pollution than what shorter runs would have indicated, as the following example indicates.

Figure 5.7.2 shows a time series plot of tracer gas concentration on 04/06 of the current study for Bus 982. (Unlike most of the other runs, the bus cabin was not flushed between runs.) For reference, Figure 5.7.2 shows the average self-pollution for the same bus in the previous study, 0.0275%. For the tracer gas being released from the low position (propene in Run 17 and SF<sub>6</sub> in Run 18), concentrations increased for at least the first 15 minutes of each run, giving run averages lower than what might be expected if the run had continued for a longer time. The tracer concentrations also appear to reach the 0.0275% level of the previous study after 15 to 30 minutes, although the 30-minute run averages were 0.018% and 0.022%, respectively.



**Figure 5.7.2** Time series for 0406 run in current study and average self-pollution value (0.0275%) from our previous study.

#### 5.7.4 Summary of Comparisons between Studies

The differences described above between our two school bus studies limits our ability to make a direct comparison, particularly for self-pollution. However, it appears the older bus population, more congested routes, and more frequent morning runs with calms winds in our previous study may have contributed to relatively higher rates of observed self-pollution compared to the current study. It should be noted the conditions in our previous study were specifically chosen to represent real-world conditions, while the conditions in the current study were not. Because the current study was focused on mitigation measures, selecting conditions truly representative of school

bus operating conditions was not necessary because the paired contrasts of various mitigation methods were made simultaneously under identical conditions.

For the bus used in both studies, Bus 982, we observed self-pollution rates to agree within a factor of two, with at least part of the difference explained by differences in run duration. Similarly, the slower average bus speeds and wind speeds in the previous study and resulting decreases in bus ventilation also likely contributed to the higher self-pollution observed for this bus.

## 6.0 CONCLUSIONS AND RECOMMENDATIONS

### 6.1 Exhaust Leak Potential and Bus Cabin Leak Potential

Determination of exhaust leak potential was measured using a backpressure method. A silicon stopper was placed in the bus's exhaust pipe and the backpressure was recorded. Buses were also checked for physical markers of exhaust leaks such as visible carbon streaks. As expected, none of the buses revealed substantial leaks in their exhaust systems and backpressure measurements appeared to depend on engine type.

Bus cabin leak potential for the same 17 buses were measured using the "blower door" method. Cabin pressure was measured while a blower was used to pressurize the cabin. Cabin pressure appeared to be related to bus age with older buses generally being leakier than newer ones. The greatest potential for leaks was located at the bottom of the bus door. The "blower door" method could be utilized by school districts to identify leaky buses and to use these buses on the shortest bus routes.

### 6.2 Tracer Gas Release System

In this study we were able to more accurately measure self-pollution by maintaining a relatively constant concentration of tracer gas in the exhaust of the instrumented bus and/or leader bus. This was accomplished by metering SF<sub>6</sub> and propene tracer gas into the tailpipe based on engine intake flow, which we used as a proxy for engine exhaust flow. Knowing these two parameters, exhaust and tracer gas flow rates, we determined that tracer gas concentration in the exhaust remained relatively stable. Thus, our calculated values of self-pollution were more accurate than in our previous study, although conditions in the current study were much less conducive to higher rates of self-pollution than in the previous study.

### 6.3 Mitigation Strategies

A number of buses were tested for overall leak rate and presence of exhaust leaks. Four buses representative of California's school bus fleet were selected for testing. The following mitigation strategies were evaluated: high exhaust position, power ventilation (blower), a combination of the two, and window seals. Tests were conducted with a single instrumented bus to test for self-pollution, or with both an instrumented bus (follower bus) and leader bus to test for exhaust intrusion from the leader bus.

#### 6.3.1 Mobile Runs

Our data suggest high exhaust was a useful mitigation strategy to reduce self-pollution, while the powered ventilation strategy had mixed results. The additional ventilation provided by a blower appeared to reduce self-pollution on a moving bus with the standard low exhaust release height, but its success as a mitigation strategy was occasionally offset when exhaust plumes reached the blower inlet, causing dramatic impacts to bus cabin air. In the mobile leader exhaust tests, the mitigation strategies were less effective in reducing exhaust intrusion into the follower bus than they were in reducing self-pollution.

The combination of high exhaust and power ventilation was expected to have a positive synergistic effect in reducing self-pollution and/or exhaust intrusion. However, the combination of the two mitigation strategies increased potential for self-pollution and exhaust intrusion compared to either strategy in isolation.

In the leader exhaust-follower exhaust runs, the effect of exhaust intrusion was larger than

that of self-pollution. The use of power ventilation on the follower bus while windows were closed did not appear to reduce self-pollution and appeared to increase exhaust intrusion from the leader bus. The results obtained with follower bus windows open were similar to the runs where windows were closed and the blower was on.

Another strategy tested was sealing the window areas, as windows were suspected to be a major pathway for self-pollution. This test showed no difference between windows sealed and windows not sealed, suggesting the windows were not a major entry point for self-pollution. Other entry points may include the openings where rear seats are bolted to the bus frame and the floorboards.

### 6.3.2 Stationary Runs

Results from stationary testing further supported the results from mobile runs. Self-pollution and exhaust intrusion data from stationary testing were generally higher than observed from mobile testing, although some of this difference may have been due to calm wind conditions during the morning hours when the stationary tests were conducted. During stationary leader exhaust testing, a majority of runs showed reduced exhaust intrusion when the exhaust was in the high position. This suggests high exhaust may be effective in reducing exhaust intrusion under stationary conditions corresponding to idling in congested traffic or at stop lights, stop signs, or bus stops.

### 6.4 Comparison to Previous Bus Study

When we compared the results from the current study to those from the previous school bus study, we found self-pollution in buses for the previous study were higher than the self-pollution observed for the buses in the current study. Several factors may explain this difference. First, tracer gas was metered into the bus's exhaust in proportion to exhaust intake flow resulting in a near constant concentration of tracer gas in the exhaust. This release system was an improvement on the previous study (Fitz et al. 2003). Second, the two studies utilized different test routes with different average speeds and durations. Third, longer runs were conducted in the previous study, and it was observed in the current study that under some conditions, self-pollution was still increasing after one half hour, the length of current study runs. Fourth, all comparable runs between the two studies in terms of self-pollution (windows closed), were conducted during different times of the day. In the previous study, all closed window runs were conducted in the morning when wind conditions were calm. In the current study, all mobile self-pollution runs were conducted in the afternoon when winds speeds were elevated compared to the morning hours. These differences may account for much of the difference in the amount of self-pollution observed in the two studies.

### 6.5 Recommendations

The strategy to raise the exhaust to a level above the roof appeared to be the best method to reduce self-pollution and this is the strategy we recommend. The use of a blower, particularly the combination of high exhaust and blower, increased the potential for self-pollution and exhaust intrusion. These two strategies should not be utilized simultaneously.

The leader exhaust-follower exhaust testing also supported the recommendation made in our previous study against allowing buses to closely follow each other (Fitz et al., 2003), a frequent practice. Other recommendations made still apply: replacing dirty buses with cleaner buses such as CNG-fueled or trap-outfitted diesel buses; staggering bus departures from a school; and instructing drivers to avoid closely following other diesel buses (i.e. the minimum following distance for traffic safety is not sufficient to minimize exhaust intrusion from the leader vehicle).

## 7.0 RECOMMENDATIONS FOR FUTURE RESEARCH

While this research project made significant progress in determining how to most effectively minimize children's exposure to vehicle pollutants when riding on school buses, there are several areas where additional research is recommended.

We were unable to determine the precise mechanism by which self-pollution occurs. It is likely exhaust intrusion results from a combination of a number of factors such as sizes and shapes of leak points; distance from the exhaust; position of the exhaust with respect to the bus cabin; and pressure differential between inside and outside leak points. Merely sealing the bus may not be an advantage, as self pollution is lower with the windows open rather than closed. In addition, all vehicles need ventilation to prevent the accumulation of breath CO<sub>2</sub>. If specific areas of the bus cabin were the most likely to cause self-pollution could be identified, then an effort could be made to seal them and leave other leaks (or actually install vents) at other areas that would be more likely to be a leak source of relatively clean air (a phenomenon that we have observed).

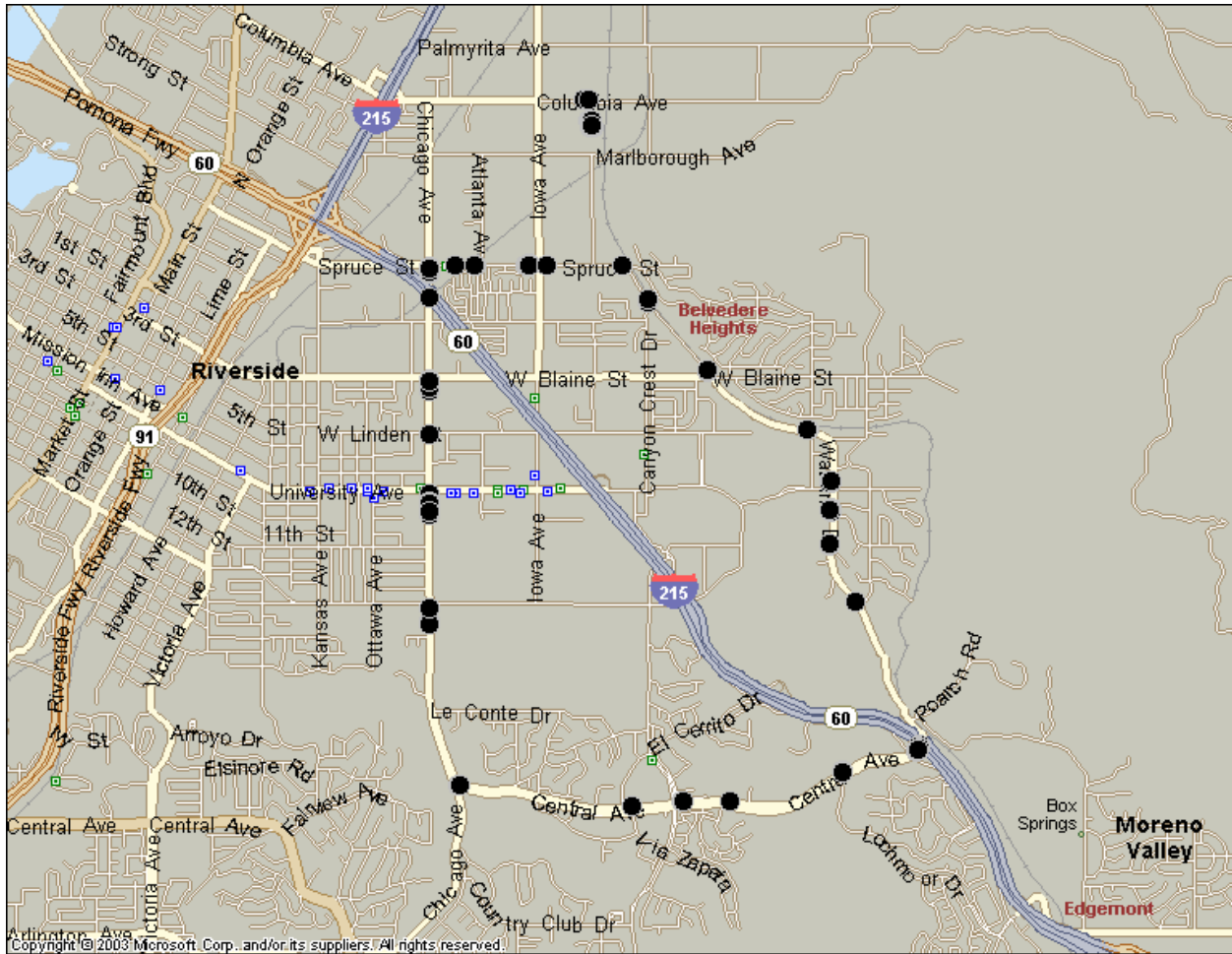
Power ventilation using a single intake point near the front of the bus gave mixed results, as this point was at times in a location significantly impacted by the bus's own exhaust. Evaluation of different air intake points or perhaps multiple intake points may allow this mitigation measure to be more effective. A multi-point intake system, for example, may reduce the periodic high concentration exposures and provide more consistent air quality since it is unlikely that that the more than one of intake positions would be subject to high concentrations of exhaust at the same time. Power ventilation may also be more effective if an activated carbon air filtration system was used, a common approach on automobiles.

While a detailed and comprehensive research plan would be needed to formulate a thorough approach to determine the mechanism and magnitude of leaks that cause self-pollution, we can provide, based on our experience, several potential approaches, including under which conditions self pollution is most likely to occur. For example, the speed of the bus and the speed and direction of the wind are likely to have major influences. While our test route contained a wide variety of these parameters (and thus was suitable for an overall evaluation), it was beyond the scope of this project to hold these parameters constant. Thus using a single direction of a test track where speed and orientation to the wind could be varied between runs, but held constant during each test run would be highly informative as to which conditions lead to greater amounts of self-pollution. For example, self pollution may be insignificant above a certain speed relative to a component of wind speed. If speed is a factor, then tracer experiments to pinpoint leaks would need to be made with either the bus moving or in a wind tunnel. The former would be impractical and unsafe on a public road and the latter would be excessively expensive. Alternatives would be to conduct tests while stationary with the respect to wind using either the prevailing winds at an appropriate location or to mount a platform on a bus roof so that experimenters could vary the tracer probe's location while operating the bus on a controlled test track.

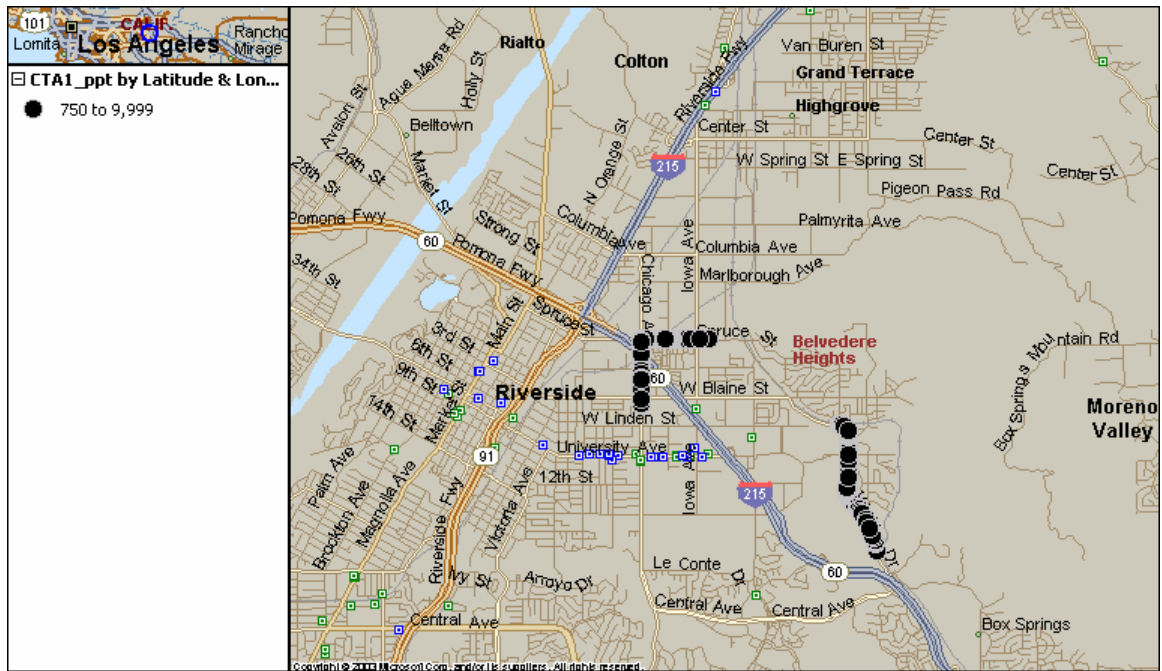
Qualitative data analysis would also be facilitated by using software packages that allow a visualization of data to evaluate the degree of self-pollution under various conditions that are difficult to determine by the statistical approaches alone. Microsoft MapPoint®, for example, is a visualization tool that we explored. Figure 7.1 shows the locations during a test run on Route 1 where the bus speed is less than 2 mph and Figure 7.2 shows locations where the SF<sub>6</sub>



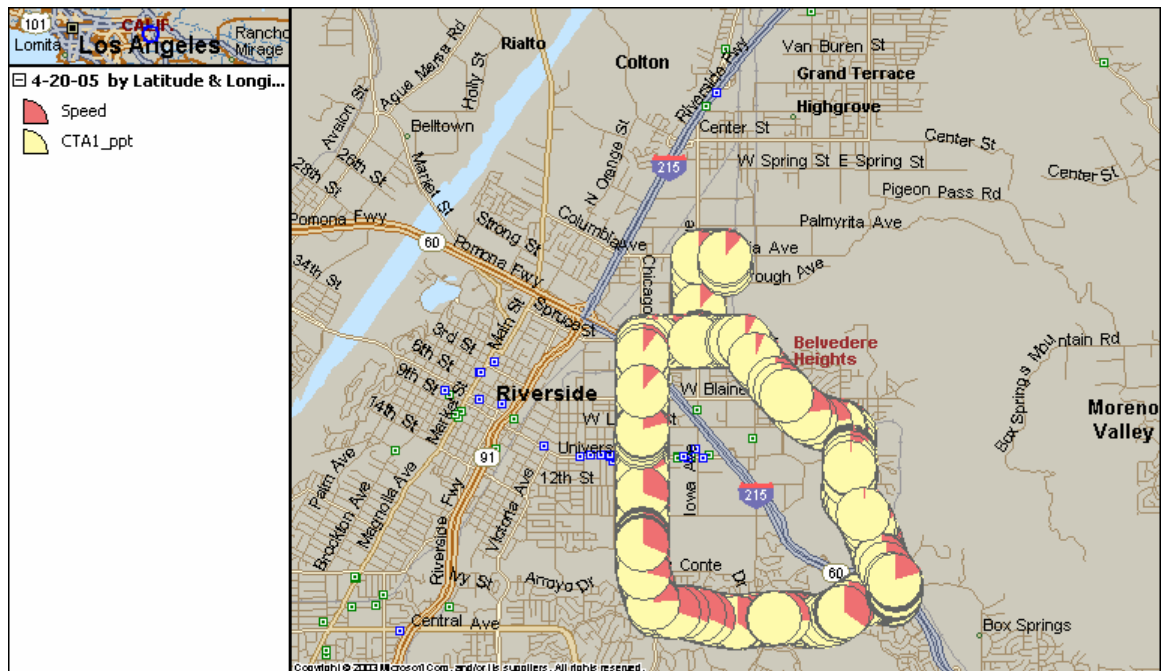
concentration is higher than 750 ppt. Note that route locations of low speed and high SF<sub>6</sub> concentrations appear to be similar. Figure 7.3 expresses this in another way by plotting the speed and SF<sub>6</sub> concentration for this test run as a function of location. These figures show that speed and tracer gas concentration appear to be inversely correlated at some of the locations. Any degree of resolution is possible with MapPoint, down to individual data points. MapPoint therefore appears to be a useful tool in analyzing the data to determine the speed and conditions that influence self-pollution.



**Figure 7.1** MapPoint locations where the speed was less than 2 mph along Route 1 during a test run conducted on 4-20-05.



**Figure 7.2** MapPoint locations of where the SF6 was greater than 750 ppt along Route 1 during a test run conducted on 4-20-05.



**Figure 7.3** MapPoint locations of SF6 concentrations and speed along Route 1 during a test run conducted on 4-20-05.

## 8.0 REFERENCES

- Aroussi, A. and S. Aghil. 2001. The effects of air vents locations on the internal climate control of vehicles. SAE paper No. 2001-01-0287
- ASHRAE Applications Handbook (SI). 1999. American Society of Heating, Refrigerating and Air Conditioning Engineers, Incorporated.
- Behrentz, E., Fitz, D. R., Pankratz, D., Sabin, L. D., Colome, S. D., Fruin, S., and Winer, A. M. 2004. Measuring self-pollution in school buses using a tracer gas technique. *Atmospheric Environment*, 38: 3735-3746.
- Behrentz, E., Sabin, L. D., Winer, A. M., Fitz, D. R., Pankratz, D. V., Colome S. D., Fruin, S. A. 2005. Relative importance of school bus-related microenvironments to children's pollutant exposure. *Journal of the Air and Waste Management Association*, 55: 1418-1430.
- Brauer, M., Hsieh, J., Copes, R. 2000. School Bus Air Quality. Final Report. School of Occupational and Environmental Hygiene. University of British Columbia.
- California Department of Education, Office of School Transportation. 2002. Student Transportation Information, available at <http://www.cde.ca.gov/bus/fastfacts.pdf>.
- Chan, C. C., Ozkaynak, H., Spengler, J., Sheldon, L. 1991. Driver exposure to volatile organic compounds, CO, ozone and NO<sub>2</sub> under different driving conditions. *Environmental Science and Technology*, 25: 964-972.
- Clifford, M. J., Clarke, R., Riffat, S. B. 1997. Local aspects of vehicular pollution. *Atmospheric Environment*, 31: 271-276.
- Conceição, E. Z. E., Silva, M. C. G., Viegas, D. X. 1997a. Air quality inside the passenger compartment of a bus. *Journal of Exposure Analysis and Environmental Epidemiology*, 7(4): 521-534.
- Conceição, E. Z. E., Silva, M. C. G., Viegas, D. X. 1997b. Airflow around a passenger seated in a bus. *International Journal on Heating Air Conditioning and Refrigerating Research*, 3(4): 311-323
- Fitz, D.R. 2003. Evaluation of emission control equipment in a school bus application. Final Report to Donaldson Corporation, Minneapolis, MN.
- Escutia, M. 1999. California Senate Bill 25: Children's Environmental Health Protection Act.
- Fitz, D. R., Winer, A. M., Colome, S. D., Behrentz, E., Sabin, L. D., Lee, S. J., Wong, K., Kozawa, K., Pankratz, D., Bumiller, K., Gemmill, D., Smith, M. 2003. Characterizing the range of children's pollutant exposure during school bus commutes. Final Report to California Air Resources Board, Research Division, Sacramento, CA.
- Fitz, D. R., Winer, A. M., Behrentz, E., Kozawa, K., Pankratz, D. 2004. Evaluation of mechanisms of exhaust intrusion into school buses and feasible mitigation measures. Pilot Study

Report to the California Air Resources Board, Research Division, Sacramento, CA.

Fletcher, B., and C.J. Saunders. 1994. Air change rates in stationary and moving vehicles. *Journal of Hazardous Materials*, 38: 243-246.

Ishihara, Y., Hara, J., Sakamoto, H., Kamemoto, K., Okamoto, H. 1991. Determination of flow velocity distribution in a vehicle interior using a visualization and computation techniques. SAE paper No. 910310.

Komoriya, T. 1989. Analysis of vehicle passenger compartment ventilation using experimental and numerical model. SAE paper No. 890312.

Lee, S. J., Yoon, J. H, Kim, K. W. 1998. Simultaneous measurement of temperature and velocity fields of ventilation flows in a passenger compartment. SAE paper No. 980292.

Long, J. 2000. Personal communication to California Air Resources Board, Mobile Source Control Division, Analysis Section, El Monte, CA.

Lipsett, M. 1989. *The Hazards of Air Pollution to Children*. Environmental Medicine, S. Brooks et al. Eds. Mosby. St. Louis.

Oshio, F., Kurosaka, K., and K. Okumura. 2001. Analysis of air ventilation performance based on aerodynamics simulation. SAE paper No. 2001-01-0296.

Ott, W. R., Langan, L., Switzer, P. 1992. A time-series model for cigarette smoking activity patterns: model validation for carbon monoxide and respirable particles in a chamber and an automobile. *Journal of Exposure Assessment and Environmental Epidemiology*, 2(Supplement 2): 175-200.

Park, J. H., Spengler, J. D., Yoon, D. D., Dumyahn, T., Lee, K., Ozkaynak, H. 1998. Measurement of air exchange rate of stationary vehicle and estimation of in-vehicle exposure. *Journal of Exposure Analysis and Environmental Epidemiology*, 8(1): 65-78

Phillips, T. J., Jenkins, P. L., Mulberg, E. J. 1991. Children in California: activity patterns and presence of pollutant sources. *Proceedings of the 84<sup>th</sup> Annual Meeting of the Air and Waste Management Association*, Pittsburg, PA.

Pope, A. 1989. Respiratory disease associated with community air pollution and a steel mill. Utah Valley. *American Journal of Public Health*, 79: 623-628.

Sabin, L. D., Behrentz, E., Winer, A. M, Jeong, S., Fitz, D. R., Pankratz, D., Colome, S. D., Fruin, S. 2005a. Characterizing the range of children's air pollutant exposure during school bus commutes. *Journal of Exposure Assessment and Environmental Epidemiology*, 15: 377-387.

Sabin, L. D., Kozawa, K., Behrentz, E., Winer, A. M, Fitz, D. R., Pankratz, D., Colome, S. D., Fruin, S. 2005b. Analysis of real-time variables affecting children's exposure to diesel-related

pollutants during school bus commutes in Los Angeles. *Atmospheric Environment*, 39: 5243-5254.

U.S. Environmental Protection Agency. 1996. Environmental health threats to children. September.

Weisel, C. P., Lawryk, N. J., Liroy, P. J. 1992. Exposure to emissions from gasoline within automobile cabins. *Journal of Exposure Analysis and Environmental Epidemiology*, 2 (1): 79-96.

Wu, C. C., Suarez, A. E., Lin, Z. B., Kidwell, C. B., Borgoul, P. V., Caffrey, P. F., Ondov, J. M., Sattler, B. 1998. Application of an Ir tracer to determine soot exposure to students commuting to school on Baltimore public buses. *Atmospheric Environment*, 32: 1911-1919.

Wiley, J. A., Robinson, J. P., Cheng, Y. T., Piazza, T., Stork, L., Pladsen, K. 1991. Study of children's activity patterns. Final Report. Contract No. A773-149. California Air Resources Board, Research Division, Sacramento, CA.

Ziskind, R. A., Rogozen, M. B., Carlin, T., Drago, R. 1981. Carbon monoxide intrusion into sustained-use vehicles. *Environment International*, 5: 109-123.

## **9.0 INVENTIONS REPORTED AND COPYRIGHTED MATERIALS PRODUCED**

None.

## 10.0 GLOSSARY OF TERMS, ABBREVIATIONS, AND SYMBOLS

|                               |   |
|-------------------------------|---|
| ARB                           | California Air Resources Board  |
| ASHRAE                        | American Society of Heating, Refrigerating and Air-Conditioning Engineers |
| CE-CERT                       | College of Engineering-Center for Environmental Research and Technology   |
| C <sub>3</sub> H <sub>6</sub> | propene   |
| CO                            | carbon monoxide   |
| CO <sub>2</sub>               | carbon dioxide  |
| CNG                           | compressed natural gas  |
| EPA                           | United States Environmental Protection Agency                             |
| NO <sub>2</sub>               | nitrogen dioxide  |
| PAH                           | polycyclic aromatic hydrocarbons  |
| PID                           | photoionization detector  |
| SF <sub>6</sub>               | sulfur hexafluoride   |
| SO <sub>2</sub>               | sulfur dioxide  |
| UCR                           | University of California, Riverside                                       |
| VOC                           | volatile organic compound   |